



QUALITY  
WITHOUT  
COMPROMISE

# PRICE LIST

INDUSTRIAL

2025



# WHAT WE DO



Manually laminated hand lay-up polyester resin fiberglass to controlled thickness.



The strength of steel  
The chemical corrosion resistance of polyester.

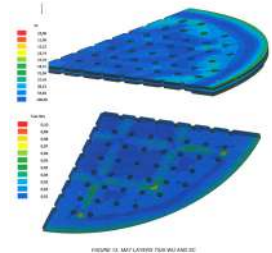

Engineering soul.



Expected lifespan: more than 30 years.

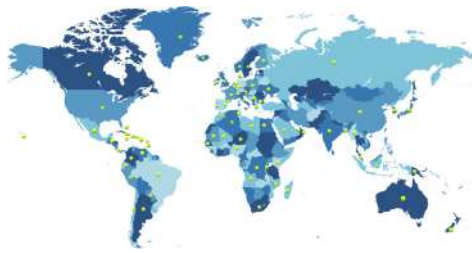

Sold worldwide with complete reliability since 1970.



Armoured nozzle plate.



Optimized distribution systems for flow distribution and each application

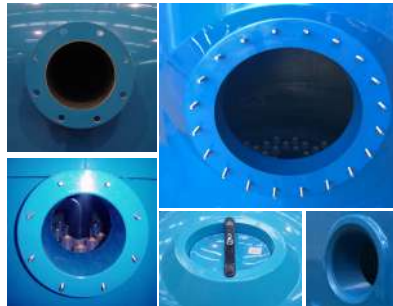

Complete safety:  
Connections are part of the structure.



100% full vision inside:  
Methacrylate sightglasses



Each and every filter is tested.



Closed legs are part of the filter structure.



On site assembling



Special colors on demand



UV resistant external gel coat.



Wind & Seismic Calculation



Replace/Upgrade your filter  
PLUG & PLAY



## CALPLAS PRESSURE VESSELS

Calplas vessels have been used in industrial projects worldwide since 1970 and it is one of the most experienced filter manufacturer in the world. A continuous growth, stimulated by a very hard working, experienced team, and a mechanical engineer soul has allowed us to become a quality and reliability reference. During this period our manufacturing has demonstrated the complete reliability of our products. Our daily contact with water treatment companies and experienced pool distributors all over the world has also helped us to innovate and to gain an advantage over our competitors responding to new water treatment challenges. This experience has also allowed us to trial new materials in order to overcome specific project water treatment requirements.

### WHY CALPLAS?

The first question is which is the best material for a vessel?

Steel tanks :

PROS: Very reliable and strong vessels.

CONS: These suffer from corrosion and require continuous maintenance to replace the different linings used (epoxy painting, rubber coatings...).

Fiber Glass vessels:

PROS: No corrosion.

CONS: Most polyester vessels are built for the swimming pool industry, where both pressure requirements and reliability fall far short of what is required in any industrial project.

### Why choose between one or the other?

Calplas uses only the most reliable GRP Polyester technology in its manufacturing process. MANUALLY LAMINATED HAND LAY UP. This means that the fibers are oriented in the directions of the maximum tensions of the filter, strictly calculated. On top, this is combined with encapsulated internal steel reinforcement used at all points where the filter is under additional stress. This makes our filters the most reliable on the market.

Calplas filters are as strong as steel with the corrosion resistance of the polyester reinforced with fiberglass



### OUR EXPERIENCE

No other manufacturer has more than 50 years experience in :

- Filtration systems
- Ion exchanger vessels
- Adequate internal lining adaptation

After 50 years of manufacturing in direct collaboration with water treatment companies and pool distributors, Calplas is proud to manufacture the best filters in the world, with an outstanding reliability, durability and performance.



# INDEX

FA SERIES Ø 415-960 .....	5
HFS/HFX SERIES Ø 415-960 .....	6
AFM SERIES Ø 520-960 .....	7
D SERIES Ø 415-960.....	8
DC SERIES Ø 415-960.....	9
DCP SERIES Ø 415-960.....	10
DPP SERIES Ø 415-960.....	11
FB SERIES Ø 1010-3000.....	12
D SERIES Ø 1010-3000.....	13
DC SERIES Ø 1010-3000.....	14
DP SERIES Ø 1010-3000.....	15
HORIZONTAL FILTERS.....	16
CARTRIDGE FILTERS.....	17
KP SERIES Ø 1010-1840.....	18
KPP SERIES Ø 1010-1840.....	19
DPC SERIES Ø 2040-3000.....	20
DPPC SERIES Ø 2040-3000.....	21
DPPP & KPPP SERIES Ø415-3000 .....	22
MIXED BEDS.....	23
STANDARD PUMP STRAINERS & COLLECTORS .....	24
CUSTOMIZED PUMP STRAINERS.....	25
DEGASSIFIERS .....	26
DECANTERS.....	27
TANKS & MIXING TANKS .....	28
MEDIATRAPS .....	29
AFM FILTER & PILOT PLANT SKID.....	30
ADDITIONAL ELEMENTS .....	31
AFM MEDIA .....	32-33
BESGO VALVES & ACCESORIES .....	34
FLOW METER & AIR DIFFUSERS.....	35
USEFUL INFORMATION.....	36-37
PACKAGING .....	38
NOTES.....	39

# FA SERIES Ø 415-960

## FA SERIES

Manufactured and calculated according to EN 13121-3.  
 Material: Hand lay-up polyester with fiberglass (max quality polyester tech).  
 Steel reinforced GRP vessel.  
 All threaded connections are part of the structure of the filter in GRP.  
 Closed legs & part of the filter structure.  
 Top access.  
 Design temperature 40°C.  
 Laterals distribution.  
 Top distributor according to the media/application.  
 Tested 1.5 times design pressure

## ADDITIONAL OPTIONS

Higher temperatures. (Ask us)  
 High-chemical resistance. (Ask us) [See page 31](#)  
 Anchorage system to ground. [See page 31](#)  
 Seismic calculations. (Ask us)  
 Drinking water / Food contact. (Ask us)  
 BESGO READY FILTERS [See page 34](#)

## FA SERIES BED HEIGHT 350-450

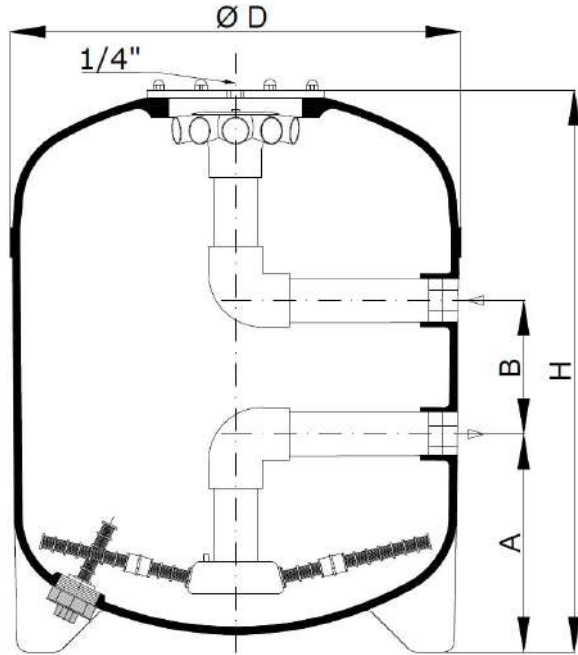

Design Pressure		FA-6 Ø415 H=730	FA-8 Ø460 H=740	FA-10 Ø520 H=800	FA-15 Ø640 H=830	FA-20 Ø720 H=930	FA-30 Ø840 H=950	FA-35 Ø960 H=1040
2.5 Kg /cm <sup>2</sup>	Ref.	102041	102046	102052	102064	102072	102084	102096
	Price	915 €	1000 €	1 195 €	1 380 €	1 630 €	1 935 €	2 740 €
5 Kg /cm <sup>2</sup>	Ref.	315041	315046	315052	315064	315072	315084	315096
	Price	1 030 €	1 095 €	1 240 €	1 675 €	2 090 €	2 480 €	3 540 €
7 Kg /cm <sup>2</sup>	Ref.	317041	317046	317052	317064	317072	317084	317096
	Price	1 325 €	1 460 €	1 695 €	2 160 €	2 745 €	3 345 €	4 450 €



Integrated GRP threads



Transparent top lid



Steel Top lid  
5 / 7 kg/cm<sup>2</sup>



Arms collector



Arms  
0.3 mm



Diffuser for Sand / AFM



Emptying plug



Besgo AG

# HFS/HFX SERIES Ø 415-960

## HFX SERIES

Manufactured and calculated according to EN 13121-3.  
 Material: Hand lay-up polyester with fiberglass (max quality polyester tech).  
 Steel reinforced GRP vessel.  
 All threaded connections are part of the structure of the filter in GRP.  
 Closed legs & part of the filter structure.  
 Top access.  
 Design temperature 40°C.  
 Laterals distribution.  
 Top distributor according to the media/application.  
 Tested 1.5 times design pressure  
 Methacrylate sightglass or methacrylate top lid (2.5kg/cm<sup>2</sup>)

## ADDITIONAL OPTIONS

Higher temperatures. (Ask us)  
 High-chemical resistance. (Ask us) [See page 31](#)  
 Flange connections available [See page 31](#)  
 Anchorage system to ground. [See page 31](#)  
 Seismic calculations. (Ask us)  
 Drinking water / Food contact. (Ask us)  
 BESGO READY FILTERS [See page 34](#)

HFS SERIES P=2.5 Kg/cm<sup>2</sup>

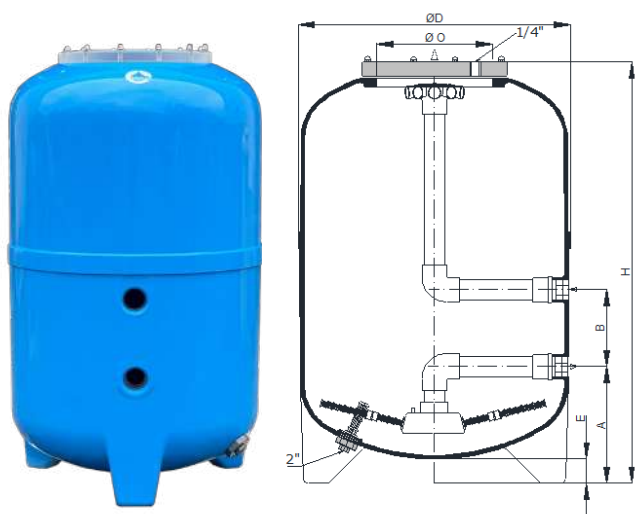

HFX SERIES P=5/7 Kg/cm<sup>2</sup>

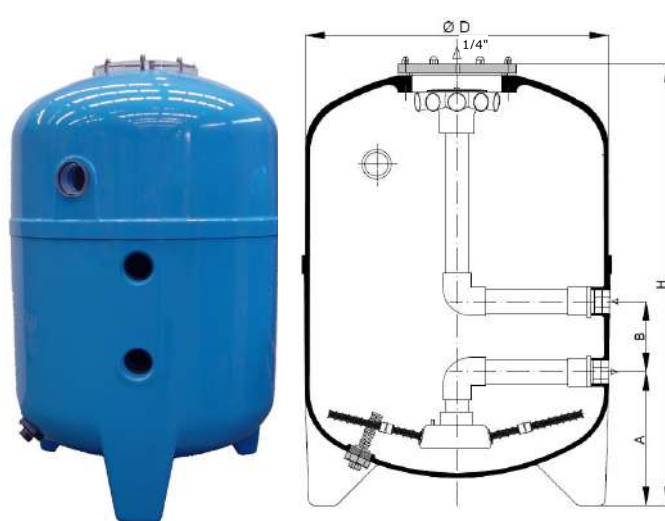

Integrated GRP threads    Optional flanges    Transparent top lid Ø415-520 P=2.5 Kg/cm<sup>2</sup>    BIG Transparent top lid Ø640-960 P=2.5 Kg/cm<sup>2</sup>    Steel Top lid 5 / 7 kg/cm<sup>2</sup>    Arms collector    Arms 0.3 mm    Diffuser for Sand / AFM    Emptying plug



Design Pressure		HFS-6 Ø415 H=861	HFS-8 Ø460 H=861	HFS-10 Ø520 H=931	HFS-15 Ø640 H=1090	HFS-20 Ø720 H=1140	HFS-30 Ø840 H=1190	HFS-35 Ø960 H=1240
2.5 Kg /cm <sup>2</sup>	Ref.	112041	112046	112052	112064	112072	112084	112096
	Price	1 020 €	1 120 €	1 355 €	1 880 €	2 165 €	2 500 €	3 255 €
Design Pressure		HFX-6 Ø415 H=861	HFX-8 Ø460 H=861	HFX-10 Ø520 H=931	HFX-15 Ø640 H=986	HFX-20 Ø720 H=1105	HFX-30 Ø840 H=1165	HFX-35 Ø960 H=1175
5 Kg /cm <sup>2</sup>	Ref.	315141	315146	315152	315164	315172	315184	315196
	Price	1 425 €	1 490 €	1 655 €	2 260 €	2 615 €	3 165 €	3 875 €
7 Kg /cm <sup>2</sup>	Ref.	317141	317146	317152	317164	317172	317184	317196
	Price	1 750 €	1 930 €	2 170 €	2 920 €	3 340 €	3 665 €	4 890 €

# AFM SERIES Ø 520-960

## AFM SERIES

Manufactured and calculated according to EN 13121-3.  
 Material: Hand lay-up polyester with fiberglass (max quality polyester tech).  
 Steel reinforced GRP vessel.  
 All threaded connections are part of the structure of the filter in GRP.  
 Closed legs & part of the filter structure.  
 Top access.  
 Design temperature 40°C.  
 Laterals distribution.  
 Top distributor according to the media/application.  
 Tested 1.5 times design pressure

## ADDITIONAL OPTIONS

Higher temperatures. (Ask us)  
 High-chemical resistance. (Ask us) [See page 31](#)  
 Flange connections available [See page 31](#)  
 Anchorage system to ground. [See page 31](#)  
 Seismic calculations. (Ask us)  
 Drinking water / Food contact. (Ask us)  
 BESGO READY FILTERS [See page 34](#)

2 Orientation available: Pos 6 X=6 (Standard) / Pos 2 X=2

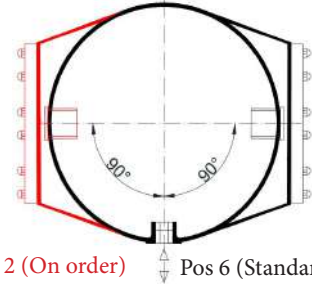

Pos 2 (On order)      Pos 6 (Standard)

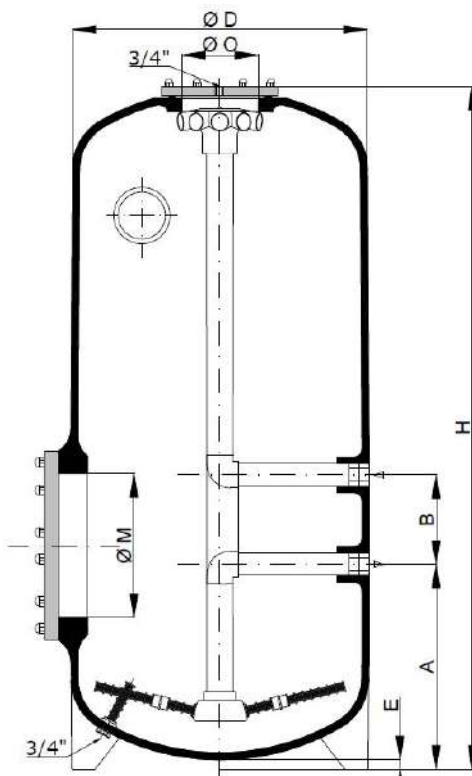

Integrated GRP threads

Transparent top lid  
2.5 Kg/cm<sup>2</sup>

Steel Top lid  
5 / 7 kg/cm<sup>2</sup>

Arms collector

Arms  
0.3 mm

Diffuser for Sand / AFM

Sightglass

Transparent side hatch  
2.5 Kg/cm<sup>2</sup>

Manhole lid  
P=5/7 Kg/cm<sup>2</sup>

Emptying plug



Design Pressure		AFM 520 H=1400	AFM 640 H=1440	AFM 720 H=1440	AFM 840 H=1460	AFM 960 H=1520
2.5 Kg/cm <sup>2</sup>	Ref.	112152.X	112164.X	112172.X	112184.X	112196.X
	Price	2 275 €	2 670 €	3 060 €	3 400 €	4 360 €
5 Kg/cm <sup>2</sup>	Ref.	315252.X	315264.X	315272.X	315284.X	315296.X
	Price	3 215 €	3 800 €	4 165 €	4 825 €	5 755 €
7 Kg/cm <sup>2</sup>	Ref.	317252.X	317264.X	317272.X	317284.X	317296.X
	Price	4 180 €	4 940 €	5 415 €	6 275 €	7 480 €

# D SERIES Ø 415-960

## D SERIES

Manufactured and calculated according to EN 13121-3.  
 Material: Hand lay-up polyester with fiberglass (max quality polyester tech).  
 Steel reinforced GRP vessel.  
 All threaded connections are part of the structure of the filter in GRP.  
 Closed legs & part of the filter structure.  
 Top & bottom access.  
 Design temperature 40°C.  
 Laterals distribution.  
 Top distributor according to the media/application.  
 Tested 1.5 times design pressure

## ADDITIONAL OPTIONS

Higher temperatures. (Ask us)  
 High-chemical resistance. (Ask us) [See page 31](#)  
 Cylindrical height ad-hoc. ([Check below](#))  
 Flange connections available. [See page 31](#)  
 Additional sight glass. [See page 31](#)  
 Anchorage system to ground. [See page 31](#)  
 Seismic calculations. (Ask us)  
 Drinking water / Food contact. (Ask us)

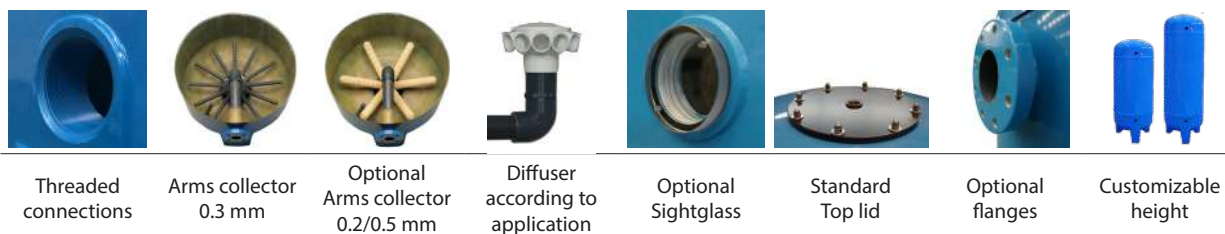
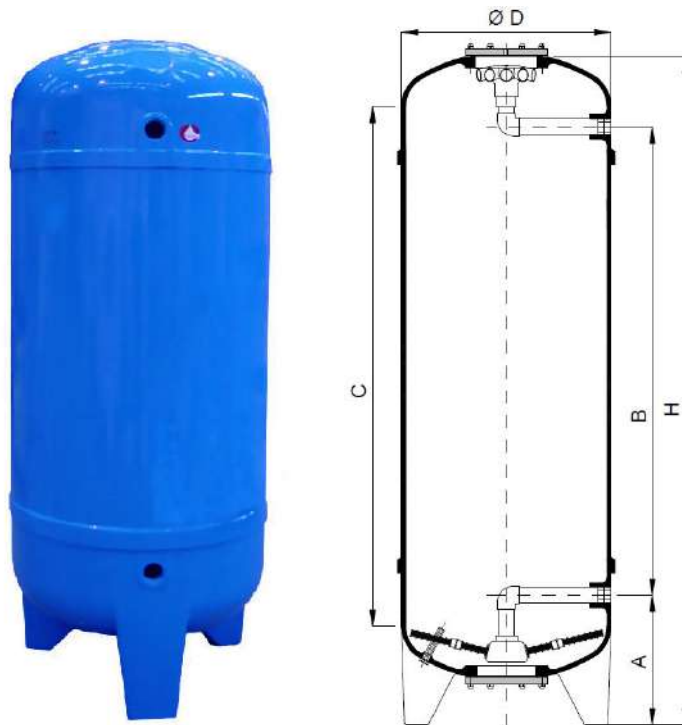

Threaded connections    Arms collector 0.3 mm    Optional Arms collector 0.2/0.5 mm    Diffuser according to application    Optional Sightglass    Standard Top lid    Optional flanges    Customizable height

Design Pressure		D-415 C=1500 H=1856	D-460 C=1500 H=1867	D-520 C=1500 H=1887	D-640 C=1500 H=1941	D-720 C=1500 H=2010	D-840 C=1500 H=2090	D-960 C=1500 H=2168
2.5 Kg /cm <sup>2</sup>	Ref.	332141	332146	332152	332164	332172	332184	332196
	Price	2 391 €	2 841 €	3 371 €	3 747 €	4 214 €	5 019 €	6 140 €
	Δ 100 mm	30 €	38 €	51 €	66 €	79 €	104 €	110 €
5 Kg /cm <sup>2</sup>	Ref.	335141	335146	335152	335164	335172	335184	335196
	Price	2 949 €	3 493 €	4 143 €	4 596 €	5 200 €	6 174 €	7 536 €
	Δ 100 mm	46 €	62 €	73 €	90 €	110 €	148 €	163 €
7 Kg /cm <sup>2</sup>	Ref.	337141	337146	337152	337164	337172	337184	337196
	Price	3 672 €	4 358 €	5 247 €	5 731 €	6 451 €	7 707 €	9 320 €
	Δ 100 mm	59 €	78 €	80 €	116 €	150 €	189 €	231 €

Recomended!	Sightglass	+300 €	+300 €	+300 €	+375 €	+375 €	+375 €	+435 €
-------------	------------	--------	--------	--------	--------	--------	--------	--------

Minimum C Check out FA & HFX models (Page 6)

Maximum C for 1 cylinder Table valid for calculation up to 2500 mm

We can manufacture filters for higher cylindrical height (please check with us)



# DC SERIES Ø 415-960

## DC SERIES

Manufactured and calculated according to EN 13121-3.  
 Material: Hand lay-up polyester with fiberglass (max quality polyester tech).  
 Steel reinforced GRP vessel.  
 All threaded connections are part of the structure of the filter in GRP.  
 Closed legs & part of the filter structure.  
 Manhole access.  
 Top & bottom access.  
 Design temperature 40°C.  
 Laterals distribution.  
 Top distributor according to the media/application.  
 Tested 1.5 times design pressure

## ADDITIONAL OPTIONS

Higher temperatures. (Ask us)  
 High-chemical resistance. (Ask us) [See page 31](#)  
 Cylindrical height ad-hoc. (**Check below**)  
 Flange connections available. [See page 31](#)  
 Sight glass. [See page 31](#)  
 Anchorage system to ground. [See page 31](#)  
 Seismic calculations. (Ask us)  
 Drinking water / Food contact. (Ask us)

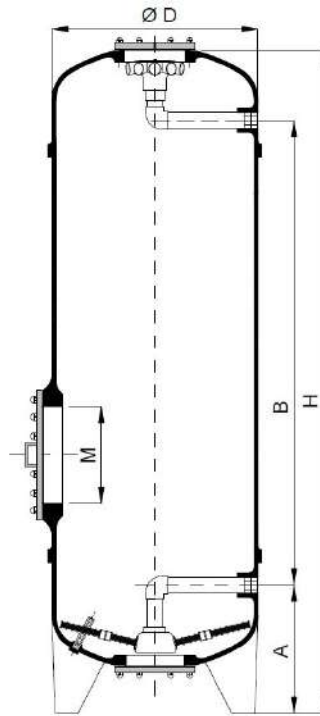

Threaded connections    Plastized Manhole lid    Arms collector 0.3 mm    Optional Arms collector 0.2/0.5 mm    Diffuser according to application    Optional sightglass    Standard Top lid    Optional flanges    Customizable height

Design Pressure		DC-415 C=1500 H=1856	DC-460 C=1500 H=1867	DC-520 C=1500 H=1887	DC-640 C=1500 H=1941	DC-720 C=1500 H=2010	DC-840 C=1500 H=2090	DC-960 C=1500 H=2168
2.5 Kg/cm <sup>2</sup>	Ref.	332241	332246	332252	332264	332272	332284	332296
	Price	3 305 €	3 755 €	4 285 €	4 854 €	5 323 €	6 127 €	7 488 €
	Δ 100 mm	30 €	38 €	51 €	66 €	79 €	104 €	110 €
5 Kg/cm <sup>2</sup>	Ref.	335241	335246	335252	335264	335272	335284	335296
	Price	3 862 €	4 407 €	5 057 €	5 705 €	6 308 €	7 283 €	8 886 €
	Δ 100 mm	46 €	62 €	73 €	90 €	110 €	148 €	163 €
7 Kg/cm <sup>2</sup>	Ref.	337241	337246	337252	337264	337272	337284	337296
	Price	4 585 €	5 271 €	6 161 €	6 837 €	7 558 €	8 814 €	10 668 €
	Δ 100 mm	59 €	78 €	80 €	116 €	150 €	189 €	231 €
<b>Recomended!</b>	<b>Sightglass</b>	<b>+300 €</b>	<b>+300 €</b>	<b>+300 €</b>	<b>+375 €</b>	<b>+375 €</b>	<b>+375 €</b>	<b>+435 €</b>
<b>Minimum C for manhole</b>		<b>924</b>	<b>928</b>	<b>928</b>	<b>974</b>	<b>965</b>	<b>965</b>	<b>1082</b>
<b>Maximum C for 1 cylinder</b>		<b>Table valid for calculation up to 2500 mm</b>						

We can manufacture filters for higher cylindrical height (please check with us)

# DCP SERIES Ø 415-960

## DCP SERIES

Manufactured and calculated according to EN 13121-3.  
 Material: Hand lay-up polyester with fiberglass (max quality polyester tech).  
 Steel reinforced GRP vessel.  
 All threaded connections are part of the structure of the filter in GRP.  
 Closed legs & part of the filter structure.  
 Top & bottom access.  
 Design temperature 40°C.  
 Bottom nozzle plate distribution.  
 Top distributor according to the media/application.  
 Tested 1.5 times design pressure

## ADDITIONAL OPTIONS

Higher temperatures. (Ask us)  
 High-chemical resistance. (Ask us) [See page 31](#)  
 Cylindrical height ad-hoc. **(Check below)**  
 Flange connections available. [See page 31](#)  
 Additional sight glass. [See page 31](#)  
 Anchorage system to ground. [See page 31](#)  
 Seismic calculations. (Ask us)  
 Drinking water / Food contact. (Ask us)

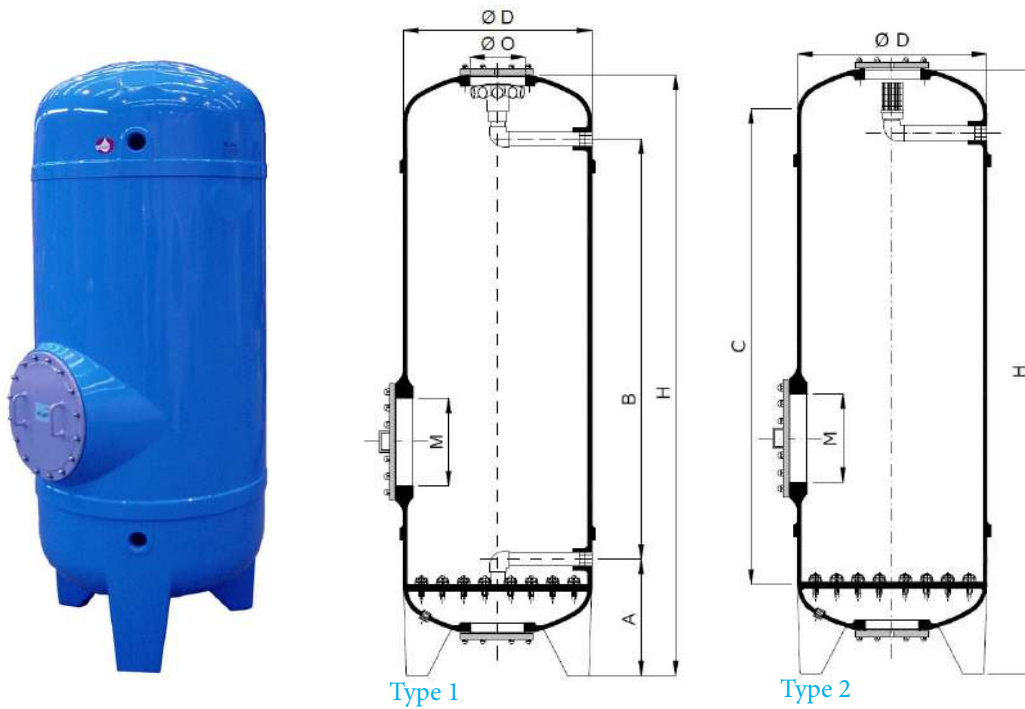

Threaded connections    Plastized Manhole lid    Steel ARMORED Nozzle plate    Nozzle plate detail    Diffuser according to application    Optional sightglass    Standard Top lid    Optional flanges    Customizable height

Design Pressure		DCP-415 C=1500 H=1856	DCP-460 C=1500 H=1867	DCP-520 C=1500 H=1887	DCP-640 C=1500 H=1941	DCP-720 C=1500 H=2010	DCP-840 C=1500 H=2090	DCP-960 C=1500 H=2168
2.5 Kg /cm <sup>2</sup>	Ref.	342141	342146	342152	342164	342172	342184	342196
	Price	3 967 €	4 466 €	5 187 €	5 900 €	6 533 €	7 746 €	9 582 €
	Δ 100 mm	30 €	38 €	51 €	66 €	79 €	104 €	110 €
5 Kg /cm <sup>2</sup>	Ref.	345141	345146	345152	345164	345172	345184	345196
	Price	4 524 €	5 116 €	5 958 €	6 751 €	7 518 €	8 902 €	10 978 €
	Δ 100 mm	46 €	62 €	73 €	90 €	110 €	148 €	163 €
7 Kg /cm <sup>2</sup>	Ref.	347141	347146	347152	347164	347172	347184	347196
	Price	5 247 €	5 980 €	7 064 €	7 883 €	8 768 €	10 434 €	12 760 €
	Δ 100 mm	59 €	78 €	80 €	116 €	150 €	189 €	231 €
Recommended!	Sightglass	+300 €	+300 €	+300 €	+375 €	+375 €	+375 €	+435 €
Minimum C for manhole		924	928	928	974	965	965	1082
Maximum C for 1 cylinder		Table valid for calculation up to 2500 mm						

We can manufacture filters for higher cylindrical height (please check with us)

# DPP SERIES Ø 415-960

## DPP SERIES

Manufactured and calculated according to EN 13121-3.  
 Material: Hand lay-up polyester with fiberglass (max quality polyester tech).  
 Steel reinforced GRP vessel.  
 All threaded connections are part of the structure of the filter in GRP.  
 Closed legs & part of the filter structure.  
 Top & bottom access.  
 Design temperature 40°C.  
 Bottom nozzle plate distribution.  
 Top nozzle plate distribution.  
 Tested 1.5 times design pressure  
 Resin transfer flanges DN65 included

## ADDITIONAL OPTIONS

Higher temperatures. (Ask us)  
 High-chemical resistance. (Ask us) [See page 31](#)  
 Cylindrical height ad-hoc. [\(Check below\)](#)  
 Flange connections available. [See page 31](#)  
 Additional sight glass. [See page 31](#)  
 Anchorage system to ground. [See page 31](#)  
 Seismic calculations. (Ask us)  
 Drinking water / Food contact. (Ask us)

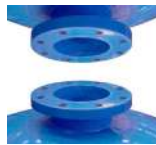
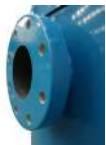
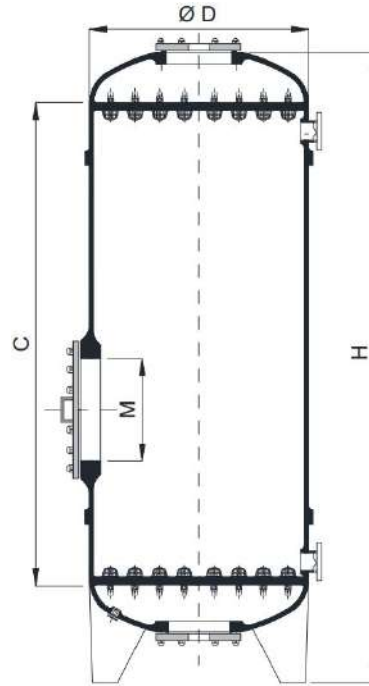

DN80 Flanges  
Load/Unload  
Included

Plastized  
Manhole lid

2 x Steel  
ARMORED  
Nozzle plate

Nozzle plate  
detail

Optional  
sightglass

Standard  
INLET  
OUTLET

Optional  
INLET  
OUTLET

Customizable  
height

Design Pressure		DPP-415 C=1500 H=1945	DPP-460 C=1500 H=1955	DPP-520 C=1500 H=1965	DPP-640 C=1500 H=2015	DPP-720 C=1500 H=2010	DPP-840 C=1500 H=2090	DPP-960 C=1500 H=2140
2.5 Kg/cm <sup>2</sup>	Ref.	342241	342246	342252	342264	342272	342284	342296
	Price	5 207 €	5 753 €	6 667 €	7 524 €	8 321 €	9 943 €	12 251 €
	Δ 100 mm	30 €	38 €	51 €	66 €	79 €	104 €	110 €
5 Kg/cm <sup>2</sup>	Ref.	345241	345246	345252	345264	345272	345284	345296
	Price	5 764 €	6 405 €	7 439 €	8 374 €	9 306 €	11 098 €	13 647 €
	Δ 100 mm	46 €	62 €	73 €	90 €	110 €	148 €	163 €
7 Kg/cm <sup>2</sup>	Ref.	347241	347246	347252	347264	347272	347284	347296
	Price	6 487 €	7 267 €	8 543 €	9 508 €	10 557 €	12 631 €	15 430 €
	Δ 100 mm	59 €	78 €	80 €	116 €	150 €	189 €	231 €
Recommended!	Sightglass	+300 €	+300 €	+300 €	+375 €	+375 €	+375 €	+435 €
Minimum C for manhole		835	840	850	900	965	965	1110
Maximum C for 1 cylinder		Table valid for calculation up to 2500 mm						

We can manufacture filters for higher cylindrical height (please check with us)

# FB SERIES Ø 1010-3000

## FB SERIES

Manufactured and calculated according to EN 13121-3.  
 Material: Hand lay-up polyester with fiberglass (max quality polyester tech).  
 Steel reinforced GRP vessel.  
 Flanged connections for INLET/OUTLET.  
 All connections are part of the structure of the filter in GRP.  
 Closed legs & part of the filter structure.  
 Side manhole & elliptical top manhole.  
 Design temperature 40°C.  
 Laterals distribution.  
 Tested 1.5 times design pressure  
 Sightglass included. (ALWAYS)

## ADDITIONAL OPTIONS

Higher temperatures. (Ask us)  
 High-chemical resistance. (Ask us) [See page 31](#)  
 Additional sight glass. [See page 31](#)  
 Anchorage system to ground. [See page 31](#)  
 Seismic calculations. (Ask us)  
 Drinking water / Food contact. (Ask us)  
**BESGO READY FILTERS "B" IN RED** [See below](#)  
 BESGO valves [See page 34](#)

## WHY FB SERIES?

FB SERIES filters are a consequence of our molds design. This filter is the solution for a lower budget without compromising manufacturing quality, with a reasonable bed height and very proper internal distribution.

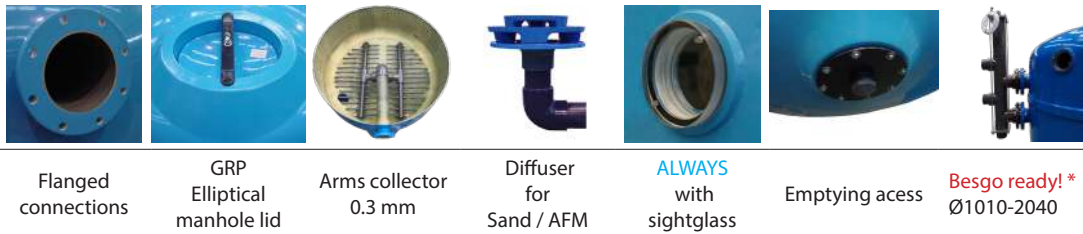
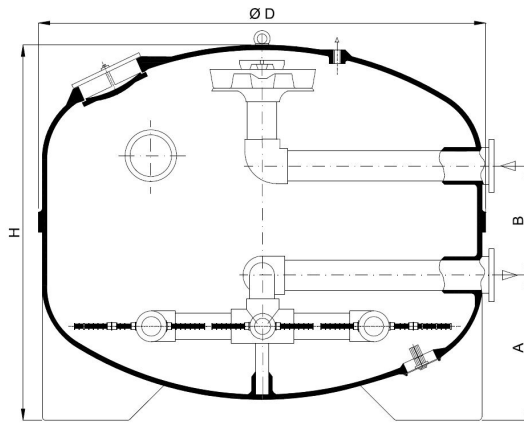

Flanged connections      GRP Elliptical manhole lid      Arms collector 0.3 mm      Diffuser for Sand / AFM      ALWAYS with sightglass      Emptying access      Besgo ready! \* Ø1010-2040

Design Pressure		FB-40 Ø1010 H=1200	FB-50 Ø1160 H=1300	FB-60 Ø1260 H=1350	FB-80 Ø1440 H=1470	FB-100 Ø1640 H=1670	FB-125 Ø1840 H=1760	FB-150 Ø2040 H=1870	FB-175 Ø2210 H=1990	FB-200 Ø2340 H=2000	FB-250 Ø2550 H=2070	FB-300 Ø2800 H=2200	FB-350 Ø3000 H=2090
2.5 Kg/cm <sup>2</sup>	Ref.	232010	232011	232012	232014	232016	232018	232020	232022	232023	232025	232028	232030
	Price	5 295 €	5 855 €	6 650 €	7 705 €	10 120 €	12 430 €	15 140 €	16 980 €	18 865 €	21 735 €	24 715 €	28 545 €
4 Kg/cm <sup>2</sup>	Ref.	314010	314011	314012	314014	314016	314018	314020	314022	314023	314025	314028	314030
	Price	7 081 €	8 090 €	9 328 €	11 110 €	14 995 €	17 909 €	21 589 €	24 502 €	25 950 €	32 131 €	38 005 €	40 799 €
5 Kg/cm <sup>2</sup>	Ref.	315010	315011	315012	315014	315016	315018	315020	315022	315023	315025	315028	315030
	Price	8 221 €	8 996 €	10 396 €	12 439 €	16 005 €	19 833 €	23 733 €	28 081 €	30 559 €	36 925 €	41 023 €	49 566 €
6 Kg/cm <sup>2</sup>	Ref.	316010	316011	316012	316014	316016	316018	316020	316022	316023	316025	316028	316030
	Price	8 797 €	9 588 €	11 395 €	13 236 €	17 355 €	21 288 €	27 204 €	33 562 €	36 011 €	41 997 €	48 800 €	55 166 €
Flanges		DN80 A=500 B=300*	DN80 A=550 B=300*	DN100 A=550 B=400*	DN100 A=625 B=400*	DN125 A=720 B=450*	DN125 A=740 B=450*	DN150 A=725 B=450*	DN200 A=760 B=605	DN200 A=765 B=600	DN250 A=760 B=700	DN250 A=850 B=650	DN250 A=check B=check
Media height *		500	600	650	720	800	850	900	1000	1000	1000	1000	900

\* Media height recommended calculated based on ~ 30% expansion on distance between laterals and top distribution

# D SERIES Ø 1010-3000

## D SERIES

Manufactured and calculated according to EN 13121-3.  
 Material: Hand lay-up polyester with fiberglass (max quality polyester tech).  
 Steel reinforced GRP vessel.  
 Flanged connections for INLET/OUTLET.  
 All connections are part of the structure of the filter in GRP.  
 Closed legs & part of the filter structure.  
 Elliptical top manhole.  
 Design temperature 40°C.  
 Laterals distribution.  
 Tested 1.5 times design pressure

## ADDITIONAL OPTIONS

Higher temperatures. (Ask us)  
 High-chemical resistance. (Ask us) [See page 31](#)  
 Cylindrical height ad-hoc. ([Check below](#))  
 Additional sight glass. [See page 31](#)  
 Anchorage system to ground. [See page 31](#)  
 Seismic calculations. (Ask us)  
 Drinking water / Food contact. (Ask us)

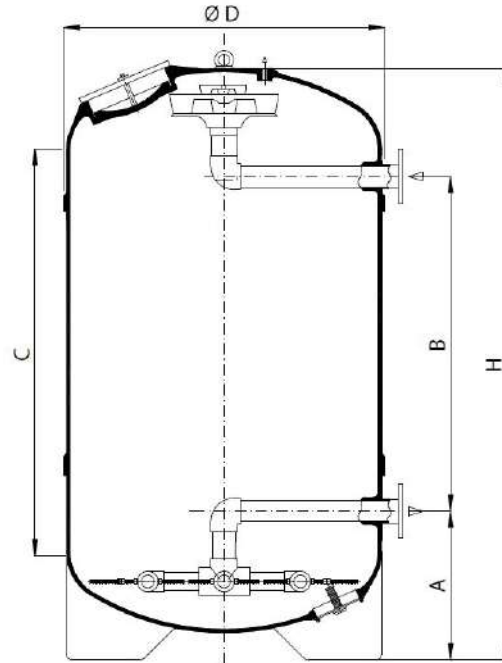

Flanged connections    GRP Elliptical manhole lid    Arms collector 0.3 mm    Diffuser for Sand / AFM    Diffuser for Ionic Exchange    Optional sightglass    Emptying access    Customizable height

Design Pressure		D-1010 C=1500 H=2000	D-1160 C=1500 H=2060	D-1260 C=1500 H=2100	D-1440 C=1500 H=2180	D-1640 C=1500 H=2260	D-1840 C=1500 H=2340	D-2040 C=1500 H=2410	D-2210 C=1500 H=2510	D-2340 C=1500 H=2530	D-2550 C=1500 H=2600	D-2800 C=1500 H=2800	D-3000 C=1500 H=2760
2.5 Kg/cm <sup>2</sup>	Ref.	352110	352111	352112	352114	352116	352118	352120	352122	352123	352125	352128	352130
	Price	7 326 €	8 550 €	9 236 €	11 236 €	14 541 €	17 783 €	20 927 €	22 605 €	24 985 €	30 034 €	32 468 €	37 700 €
	Δ 100 mm	178 €	189 €	288 €	368 €	409 €	430 €	444 €	456 €	485 €	572 €	734 €	991 €
4 Kg/cm <sup>2</sup>	Ref.	354110	354111	354112	354114	354116	354118	354120	354122	354123	354125	354128	354130
	Price	8 783 €	10 067 €	11 647 €	13 931 €	18 181 €	21 563 €	26 849 €	29 348 €	31 329 €	38 470 €	46 076 €	49 356 €
	Δ 100 mm	187 €	193 €	289 €	376 €	420 €	456 €	497 €	520 €	566 €	647 €	788 €	1 043 €
5 Kg/cm <sup>2</sup>	Ref.	355110	355111	355112	355114	355116	355118	355120	355122	355123	355125	355128	355130
	Price	10 177 €	11 184 €	12 782 €	15 829 €	19 938 €	24 266 €	29 592 €	34 321 €	37 030 €	44 567 €	51 178 €	60 356 €
	Δ 100 mm	205 €	245 €	324 €	398 €	463 €	552 €	582 €	627 €	670 €	757 €	905 €	1 065 €
6 Kg/cm <sup>2</sup>	Ref.	356110	356111	356112	356114	356116	356118	356120	356122	356123	356125	356128	356130
	Price	10 906 €	12 038 €	14 102 €	17 092 €	21 474 €	25 953 €	32 713 €	39 615 €	42 341 €	49 650 €	59 242 €	68 627 €
	Δ 100 mm	229 €	279 €	345 €	403 €	530 €	635 €	716 €	751 €	797 €	866 €	943 €	1 091 €

Recommended! Sightglass +435 € +435 € +435 € +435 € +530 € +530 € +625 € +625 € +625 € +625 € +625 € +625 €

Minimum C

D Series can be reduced up to FB model

Maximum C for 1 cylinder 2310 2350 2345 2390 2510 2520 2640 2580 2570 2650 2570 2510

We can manufacture filters for higher cylindrical height (please check with us)

# DC SERIES Ø 1010-3000

## DC SERIES

Manufactured and calculated according to EN 13121-3.  
 Material: Hand lay-up polyester with fiberglass (max quality polyester tech).  
 Steel reinforced GRP vessel.  
 Flanged connections for INLET/OUTLET.  
 All connections are part of the structure of the filter in GRP.  
 Closed legs & part of the filter structure.  
 Side manhole & elliptical top manhole.  
 Design temperature 40°C.  
 Laterals distribution.  
 Tested 1.5 times design pressure

## ADDITIONAL OPTIONS

Higher temperatures. (Ask us)  
 High-chemical resistance. (Ask us) [See page 31](#)  
 Cylindrical height ad-hoc. ([Check below](#))  
 Additional sight glass. [See page 31](#)  
 Anchorage system to ground. [See page 31](#)  
 Seismic calculations. (Ask us)  
 Drinking water / Food contact. (Ask us)  
 Lateral manhole Ø500 mm.

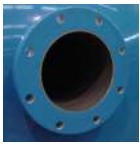
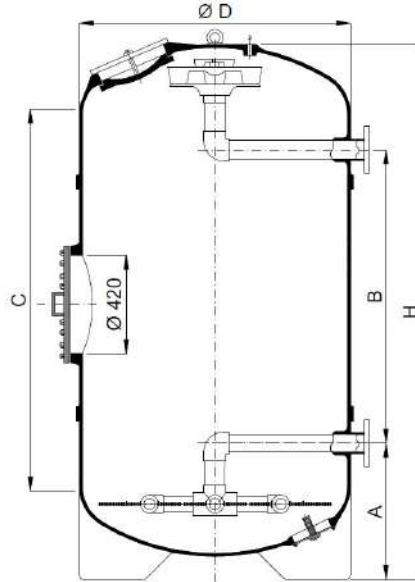

Flanged connections



Plastized Manhole lid



GRP Elliptical manhole lid



Arms collector 0.3 mm



Diffuser for Sand / AFM



Diffuser for Ionic Exchange



Optional sightglass



Emptying access



Customizable height

Design Pressure		DC-1010 C=1500 H=2000	DC-1160 C=1500 H=2060	DC-1260 C=1500 H=2100	DC-1440 C=1500 H=2180	DC-1640 C=1535 H=2295	DC-1840 C=1565 H=2405	DC-2040 C=1605 H=2515	DC-2210 C=1830 H=2840	DC-2340 C=1820 H=2850	DC-2550 C=1820 H=2920	DC-2800 C=1740 H=3040	DC-3000 C=1810 H=3070
2.5 Kg/cm <sup>2</sup>	Ref.	352210	352211	352212	352214	352216	352218	352220	352222	352223	352225	352228	352230
	Price	9 526 €	10 767 €	11 451 €	13 549 €	16 997 €	20 374 €	24 047 €	26 730 €	29 240 €	34 289 €	37 462 €	44 004 €
	Δ 100 mm	178 €	189 €	288 €	368 €	409 €	430 €	444 €	456 €	485 €	572 €	734 €	991 €
4 Kg/cm <sup>2</sup>	Ref.	354210	354211	354212	354214	354216	354218	354220	354222	354223	354225	354228	354230
	Price	10 983 €	12 283 €	13 863 €	16 243 €	20 641 €	24 166 €	29 985 €	33 534 €	35 808 €	43 221 €	51 201 €	55 820 €
	Δ 100 mm	187 €	193 €	289 €	376 €	420 €	456 €	497 €	520 €	566 €	647 €	788 €	1 043 €
5 Kg/cm <sup>2</sup>	Ref.	355210	355211	355212	355214	355216	355218	355220	355222	355223	355225	355228	355230
	Price	12 376 €	13 400 €	14 998 €	18 142 €	22 413 €	26 938 €	32 859 €	38 896 €	41 804 €	49 663 €	56 581 €	66 798 €
	Δ 100 mm	205 €	245 €	324 €	398 €	463 €	552 €	582 €	627 €	670 €	757 €	905 €	1 065 €
6 Kg/cm <sup>2</sup>	Ref.	356210	356211	356212	356214	356216	356218	356220	356222	356223	356225	356228	356230
	Price	13 107 €	14 254 €	16 318 €	19 407 €	23 972 €	28 736 €	36 210 €	44 369 €	47 285 €	54 806 €	64 739 €	75 245 €
	Δ 100 mm	229 €	279 €	345 €	403 €	530 €	635 €	716 €	751 €	797 €	866 €	943 €	1 091 €
Recomended!	Sightglass	+435 €	+435 €	+435 €	+435 €	+530 €	+530 €	+625 €	+625 €	+625 €	+625 €	+625 €	+625 €
Minimum C for manhole		1470	1510	1505	1495	1535	1565	1605	1830	1820	1820	1740	1810
Maximum C for 1 cylinder		2310	2350	2345	2390	2510	2520	2640	2580	2570	2650	2570	2510

We can manufacture filters for higher cylindrical height (please check with us)

# DP SERIES Ø 1010-3000

## DP SERIES

Manufactured and calculated according to EN 13121-3.  
 Material: Hand lay-up polyester with fiberglass (max quality polyester tech).  
 Steel reinforced GRP vessel.  
 Flanged connections for INLET/OUTLET  
 All connections are part of the structure of the filter in GRP.  
 Closed legs & part of the filter structure.  
 Side manhole & elliptical top manhole.  
 Design temperature 40°C.  
 Nozzle plate. (GRP + Steel)  
 Tested 1.5 times design pressure

## ADDITIONAL OPTIONS

Higher temperatures. (Ask us)  
 High-chemical resistance. (Ask us) [See page 31](#)  
 Cylindrical height ad-hoc.  
 Additional sight glass. [See page 31](#)  
 Anchorage system to ground. [See page 31](#)  
 Seismic calculations. (Ask us)  
 Drinking water / Food contact. (Ask us)  
 Lateral manhole Ø500 mm.  
**Shorter cylinder with Ø200mm hand hole Solution**

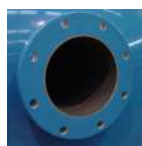
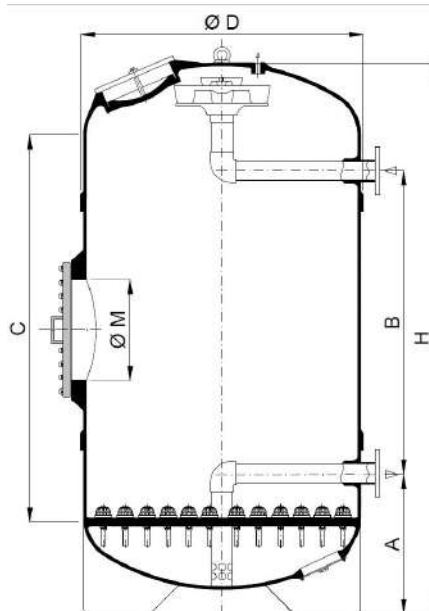

Flanged connections

Plastized Manhole lid

GRP Elliptical manhole lid

Steel ARMORED Nozzle plate

Diffuser for Sand / AFM

Diffuser for Ionic Exchange

Optional sightglass

Emptying access

Customizable height

Design Pressure		DP-1010 C=1500 H=2090	DP-1160 C=1500 H=2150	DP-1260 C=1500 H=2180	DP-1440 C=1500 H=2290	DP-1640 C=1500 H=2370	DP-1840 C=1500 H=2450	DP-2040 C=1500 H=2515	DP-2210 C=1735 H=2840	DP-2340 C=1730 H=2850	DP-2550 C=1730 H=2920	DP-2800 C=1710 H=3040	DP-3000 C=1760 H=3070
2.5 Kg/cm <sup>2</sup>	Ref.	362110	362111	362112	362114	362116	362118	362120	362122	362123	362125	362128	362130
	Price	12 058 €	14 039 €	15 432 €	18 199 €	22 937 €	26 906 €	32 572 €	36 864 €	39 776 €	46 767 €	53 721 €	62 397 €
	Δ 100 mm	178 €	189 €	288 €	368 €	409 €	430 €	444 €	456 €	485 €	572 €	734 €	991 €
4 Kg/cm <sup>2</sup>	Ref.	364110	364111	364112	364114	364116	364118	364120	364122	364123	364125	364128	364130
	Price	13 515 €	15 554 €	17 843 €	20 893 €	26 578 €	30 686 €	38 494 €	43 649 €	46 280 €	55 560 €	67 445 €	74 188 €
	Δ 100 mm	187 €	193 €	289 €	376 €	420 €	456 €	497 €	520 €	566 €	647 €	788 €	1 043 €
5 Kg/cm <sup>2</sup>	Ref.	365110	365111	365112	365114	365116	365118	365120	365122	365123	365125	365128	365130
	Price	14 909 €	16 672 €	18 980 €	22 793 €	28 334 €	33 389 €	41 237 €	48 900 €	52 192 €	61 905 €	72 789 €	85 169 €
	Δ 100 mm	205 €	245 €	324 €	398 €	463 €	552 €	582 €	627 €	670 €	757 €	905 €	1 065 €
6 Kg/cm <sup>2</sup>	Ref.	366110	366111	366112	366114	366116	366118	366120	366122	366123	366125	366128	366130
	Price	15 638 €	17 527 €	20 300 €	24 057 €	29 870 €	35 075 €	44 358 €	54 322 €	57 626 €	67 031 €	80 936 €	93 587 €
	Δ 100 mm	229 €	279 €	345 €	403 €	530 €	635 €	716 €	751 €	797 €	866 €	943 €	1 091 €
Recommended!	Sightglass	+435 €	+435 €	+435 €	+435 €	+530 €	+530 €	+625 €	+625 €	+625 €	+625 €	+625 €	+625 €
	Minimum C for manhole	1380	1420	1425	1385	1425	1455	1500	1735	1730	1730	1710	1760
	Maximum C for 1 cylinder	2220	2260	2265	2280	2400	2410	2535	2485	2480	2560	2540	2460



We can manufacture filters for higher cylindrical height (please check with us)

# HORIZONTAL FILTERS (Ø1840 - 3000)

## HORIZONTAL SERIES

Manufactured and calculated according to EN 13121-3.  
 Material: Hand lay-up polyester with fiberglass (max quality polyester tech).  
 Steel reinforced GRP vessel.  
 Flanged connections for INLET/OUTLET.  
 All connections are part of the structure of the filter in GRP.  
 Supports for the filter included (2 or 3 according to model).  
 2 x elliptical top manhole.  
 Sightglass included.  
 Design temperature 40°C.  
 Laterals distribution.  
 Tested 1.5 times design pressure

## ADDITIONAL OPTIONS

Customizable length if necessary.  
 Air backwash distribution. (Ask us)   
 Higher temperatures. (Ask us)  
 High-chemical resistance. (Ask us) [See page 31](#)  
 Additional sight glass. [See page 31](#)  
 Anchorage system to ground. [See page 31](#)  
 Flange connections in the dome. (Ask us)   
 Seismic calculations. (Ask us)  
 Drinking water / Food contact. (Ask us)  
 Additional flanges. [See page 31](#)

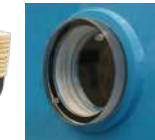
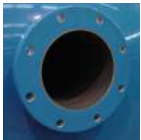
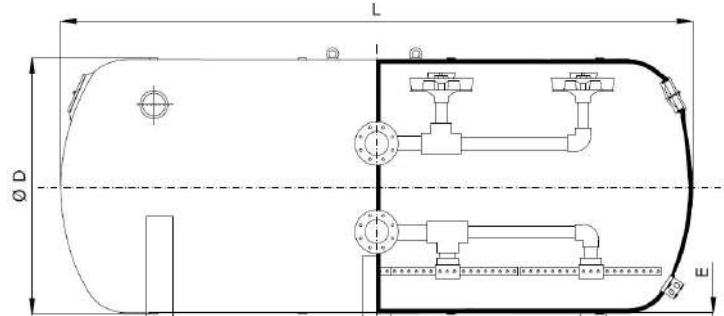

Flanged connections

Optional Plastitized Manhole lid

2 x GRP Elliptical manhole lid

Arms collector 0.3 mm

Diffuser for Sand / AFM

Diffuser for Active Carbon

ALWAYS with sightglass

Emptying access

Separated supports

Ø	Total Length	Filtering Surface	AFM (G3/Rest)	Supports	Ref.	2,5 Kg/cm <sup>2</sup>	Ref.	4 Kg/cm <sup>2</sup>	Ref.	5 Kg/cm <sup>2</sup>	Ref.	6 Kg/cm <sup>2</sup>
1840	3100	5,22 m <sup>2</sup>	1,1 4,2	2	322118	23 556 €	324118	36 282 €	325118	40 004 €	326118	47 153 €
	3900	6,50 m <sup>2</sup>	1,3 5,6	2	322218	29 216 €	324218	43 131 €	325218	52 422 €	326218	57 856 €
	4700	8,11 m <sup>2</sup>	1,5 6,8	3	322318	35 678 €	324318	52 155 €	325318	60 442 €	326318	69 829 €
	5500	9,55 m <sup>2</sup>	1,8 8,1	3	322418	39 131 €	324418	60 463 €	325418	70 189 €	326418	81 253 €
	6300	11,11 m <sup>2</sup>	2,1 9,4	3	322518	46 408 €	324518	68 705 €	325518	80 462 €	326518	92 843 €
2040	3360	6,50 m <sup>2</sup>	1,1 7,3	2	322120	29 031 €	324120	40 739 €	325120	47 155 €	326120	55 391 €
	4160	8,00 m <sup>2</sup>	1,5 8,2	2	322220	34 702 €	324220	49 213 €	325220	55 823 €	326220	67 967 €
	4960	9,50 m <sup>2</sup>	1,7 10	3	322320	41 453 €	324320	59 389 €	325320	68 371 €	326320	79 457 €
	5660	11,00 m <sup>2</sup>	2 11,3	3	322420	47 176 €	324420	68 487 €	325420	77 736 €	326420	92 246 €
	6460	12,70 m <sup>2</sup>	2,3 13,3	3	322520	52 732 €	324520	76 248 €	325520	89 349 €	326520	104 293 €
2210	3400	7,08 m <sup>2</sup>	1,3 7,8	2	322122	32 952 €	324122	46 211 €	325122	54 458 €	326122	64 097 €
	4170	8,80 m <sup>2</sup>	1,5 10	2	322222	38 167 €	324222	55 571 €	325222	63 835 €	326222	75 240 €
	5000	10,70 m <sup>2</sup>	2 11,7	3	322322	45 218 €	324322	66 369 €	325322	76 151 €	326322	88 068 €
	5720	12,40 m <sup>2</sup>	2,2 13,8	3	322422	51 011 €	324422	75 997 €	325422	86 292 €	326422	100 412 €
	6500	14,20 m <sup>2</sup>	2,5 15,8	3	322522	56 786 €	324522	84 905 €	325522	97 605 €	326522	111 946 €
2340	3520	7,40 m <sup>2</sup>	1,5 8,5	2	322123	36 082 €	324123	50 569 €	325123	60 445 €	326123	71 257 €
	4300	9,30 m <sup>2</sup>	1,8 11	2	322223	40 708 €	324223	60 586 €	325223	70 305 €	326223	80 694 €
	5100	11,20 m <sup>2</sup>	2,1 13,2	3	322323	47 892 €	324323	71 745 €	325323	82 088 €	326323	94 552 €
	5800	13,00 m <sup>2</sup>	2,5 15	3	322423	53 609 €	324423	81 672 €	325423	92 763 €	326423	106 153 €
	6600	15,00 m <sup>2</sup>	2,8 17,3	3	322523	59 465 €	324523	91 509 €	325523	103 504 €	326523	116 894 €
2550	3450	8,00 m <sup>2</sup>	2,2 9,1	2	322125	39 074 €	324125	56 003 €	325125	67 114 €	326125	79 879 €
	4350	10,00 m <sup>2</sup>	3 12	2	322225	45 276 €	324225	67 403 €	325225	79 109 €	326225	91 994 €
	5150	12,30 m <sup>2</sup>	3,5 14,5	3	322325	52 656 €	324325	80 196 €	325325	92 387 €	326325	106 366 €
	6000	14,40 m <sup>2</sup>	4,2 17	3	322425	58 813 €	324425	91 473 €	325425	103 040 €	326425	119 182 €
	6850	16,50 m <sup>2</sup>	5 20	3	322525	64 917 €	324525	103 067 €	325525	116 191 €	326525	132 977 €
2800	3680	9,30 m <sup>2</sup>	2,5 12,5	2	322128	42 787 €	324128	66 437 €	325128	79 600 €	326128	96 003 €
	4500	11,60 m <sup>2</sup>	3,5 15,5	2	322228	53 748 €	324228	79 649 €	325228	93 612 €	326228	108 724 €
	5360	14,00 m <sup>2</sup>	4 18,5	3	322328	61 261 €	324328	93 191 €	325328	108 060 €	326328	124 805 €
	6230	16,40 m <sup>2</sup>	4,5 22,5	3	322428	68 295 €	324428	106 255 €	325428	121 171 €	326428	138 525 €
	7040	18,50 m <sup>2</sup>	5,2 26	3	322528	75 814 €	324528	115 726 €	325528	133 057 €	326528	152 294 €
3000	Ask for price											



# CARTRIDGE FILTERS

## CARTRIDGE FILTER

Design pressure 6 Kg/cm<sup>2</sup>  
 Steel reinforced GRP vessel.  
 Material: Hand lay-up polyester with fiberglass (max quality polyester tech).  
 Manufactured and calculated according to EN 13121-3.  
 All connections are part of the structure of the filter in GRP.  
 Design temperature 40°C.  
 PVC pipes inside threaded to plate to insert Cartridges.  
 Tested 1.5 times design pressure

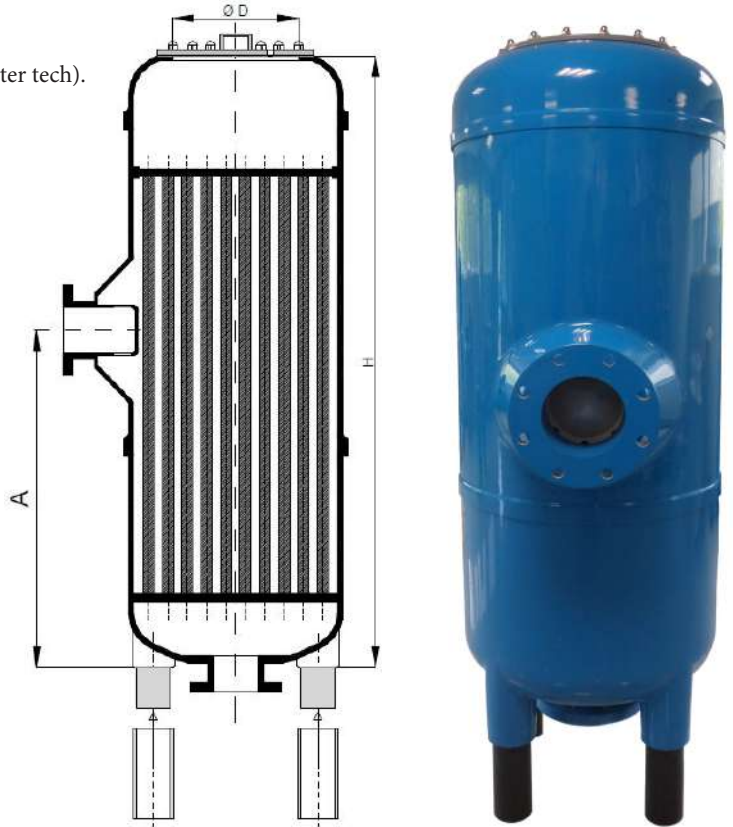
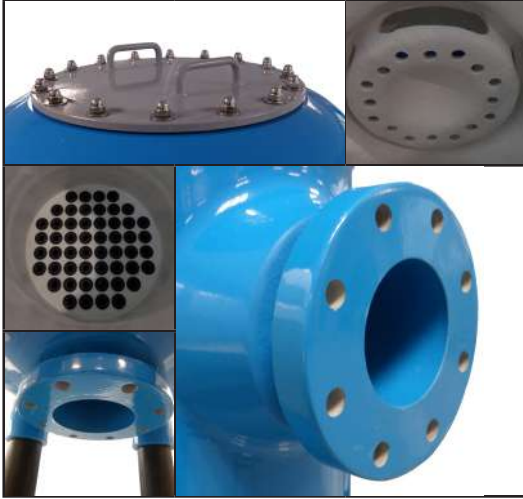

Model	CF-330/30 Ø330	CF-415/30 Ø415	CF-520/30 Ø520	CF-640/30 Ø640
Nº Cartridges	14	21	32	52
Ref	436303	436304	436305	436306
Length Cartridges	30" (28.1 m <sup>3</sup> /h)	30" (42.2 m <sup>3</sup> /h)	30" (64.3 m <sup>3</sup> /h)	30" (104.5 m <sup>3</sup> /h)
Price	5 092 €	8 175 €	9 307 €	11 923 €

Model	CF-330/40 Ø330	CF-415/40 Ø415	CF-520/40 Ø520	CF-640/40 Ø640
Nº Cartridges	14	21	32	52
Ref	436403	436404	436405	436406
Length Cartridges	40" (37.5 m <sup>3</sup> /h)	40" (56.2 m <sup>3</sup> /h)	40" (85.7 m <sup>3</sup> /h)	40" (139.3 m <sup>3</sup> /h)
Price	5 233 €	8 344 €	9 504 €	12 192 €

Recommended flow for  
 each 10" 0.67 m<sup>3</sup>/h

### Cartridges not included in the price!



TwinPure 4 layers is a new cartridge filter, manufactured with 4 different filtration layers. The patented multilayer configuration has the benefits of a deep filtration. TwinPure 4 layers has been designed without internal soul and with a high particle retention capacity and a lower initial differential pressure. The 4 layers with different miron sizes allows increase the colloidal retention capacity and reduce the filtration costs.

It is recommended to replace the filtration element at 1,0-1,5 Bar.

	5 µ
30"	14 €
40"	17 €

# KP SERIES Ø 1010-1840

## KP SERIES

Manufactured and calculated according to EN 13121-3.  
 Material: Hand lay-up polyester with fiberglass (max quality polyester tech).  
 Steel reinforced GRP vessel.  
 Flanged connections for INLET/OUTLET or PVC lid in the bottom.  
 All connections are part of the structure of the filter in GRP.  
 Closed legs & part of the filter structure.  
 Side manhole & elliptical top manhole.  
 Design temperature 40°C.  
 Bottom nozzle plate. (GRP + Steel)  
 Longer legs for bottom connection or complete drain.  
 Tested 1.5 times design pressure

## ADDITIONAL OPTIONS

Higher temperatures. (Ask us)  
 High-chemical resistance. (Ask us) [See page 31](#)  
 Cylindrical height ad-hoc. ([Check below](#))  
 Additional sight glass. [See page 31](#)  
 Additional flanges. [See page 31](#)  
 Anchorage system to ground. [See page 31](#)  
 Seismic calculations. (Ask us)  
 Drinking water / Food contact. (Ask us)  
 Lateral manhole Ø500 mm.

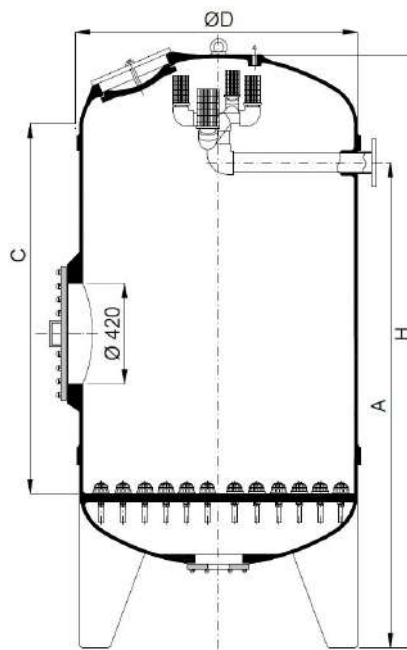

Flanged connections    Plastized Manhole lid    GRP Elliptical manhole lid    Steel ARMORED Nozzle plate    Optional Sightglass    Diffuser for Ionic exchange    Higher legs    Optional bottom flange    Customizable height

Design Pressure		KP-1010 C=1500 H=2290	KP-1160 C=1500 H=2385	KP-1260 C=1500 H=2435	KP-1440 C=1500 H=2510	KP-1640 C=1500 H=2570	KP-1840 C=1500 H=2700
2.5 Kg/cm <sup>2</sup>	Ref.	382110	382111	382112	382114	382116	382118
	Price	12 450 €	14 427 €	15 987 €	18 934 €	23 917 €	28 004 €
	Δ 100 mm	178 €	189 €	288 €	368 €	409 €	430 €
4 Kg/cm <sup>2</sup>	Ref.	384110	384111	384112	384114	384116	384118
	Price	13 885 €	16 017 €	18 476 €	21 668 €	27 677 €	31 870 €
	Δ 100 mm	187 €	193 €	289 €	376 €	420 €	456 €
5 Kg/cm <sup>2</sup>	Ref.	385110	385111	385112	385114	385116	385118
	Price	15 248 €	17 130 €	19 628 €	23 574 €	29 423 €	34 756 €
	Δ 100 mm	205 €	245 €	324 €	398 €	463 €	552 €
6 Kg/cm <sup>2</sup>	Ref.	386110	386111	386112	386114	386116	386118
	Price	16 092 €	18 119 €	21 327 €	25 075 €	31 162 €	36 564 €
	Δ 100 mm	229 €	279 €	345 €	403 €	530 €	635 €
Recomended!	Sightglass	+435 €	+435 €	+435 €	+435 €	+530 €	+530 €
Minimum C for manhole		1355	1350	1325	1295	1265	1285
Maximum C for 1 cylinder		2195	2190	2170	2190	2240	2240

We can manufacture filters for higher cylindrical height (please check with us)

# KPP SERIES Ø 1010-1840

## KPP SERIES

Manufactured and calculated according to EN 13121-3.  
 Material: Hand lay-up polyester with fiberglass (max quality polyester tech).  
 Steel reinforced GRP vessel.  
 Flanged connections for INLET/OUTLET or PVC lids.  
 All connections are part of the structure of the filter in GRP.  
 Closed legs & part of the filter structure.  
 Side manhole.  
 Design temperature 40°C.  
 Bottom nozzle plate (GRP + Steel)  
 Top nozzle plate. (GRP + Steel)  
 Longer legs for bottom connection or complete drain.  
 Tested 1.5 times design pressure  
 Resin transfer flanges DN80 included

## ADDITIONAL OPTIONS

Higher temperatures. (Ask us)  
 High-chemical resistance. (Ask us) [See page 31](#)  
 Cylindrical height ad-hoc. (Check below)  
 Additional sight glass. [See page 31](#)  
 Additional flanges. [See page 31](#)  
 Anchorage system to ground. [See page 31](#)  
 Seismic calculations. (Ask us)  
 Drinking water / Food contact. (Ask us)  
 Lateral manhole Ø500 mm.

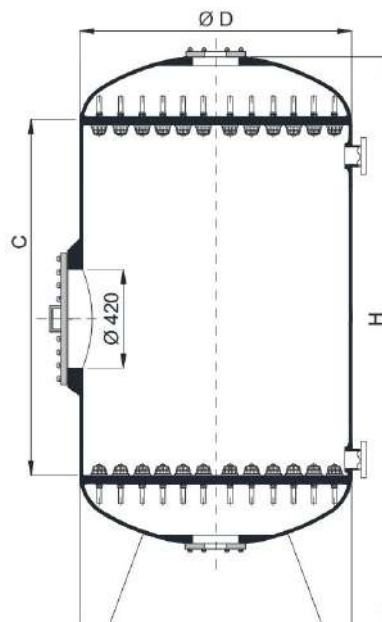

DN80 Flanges Load/Unload Included

Plastized Manhole lid

2 x Steel ARMORED Nozzle plate

Optional Sightglass

Top connection Standard

Higher legs

Optional flanged connections

Customizable height

Design Pressure		KPP-1010 C=1500 H=2325	KPP-1160 C=1500 H=2435	KPP-1260 C=1500 H=2450	KPP-1440 C=1500 H=2535	KPP-1640 C=1500 H=2585	KPP-1840 C=1500 H=2735
2.5 Kg/cm <sup>2</sup>	Ref.	382210	382211	382212	382214	382216	382218
	Price	15 689 €	18 520 €	20 839 €	24 682 €	31 222 €	36 512 €
	Δ 100 mm	178 €	189 €	288 €	368 €	409 €	430 €
4 Kg/cm <sup>2</sup>	Ref.	384210	384211	384212	384214	384216	384218
	Price	17 124 €	20 108 €	23 329 €	27 416 €	34 980 €	40 379 €
	Δ 100 mm	187 €	193 €	289 €	376 €	420 €	456 €
5 Kg/cm <sup>2</sup>	Ref.	385210	385211	385212	385214	385216	385218
	Price	18 484 €	21 223 €	24 481 €	29 322 €	36 728 €	43 263 €
	Δ 100 mm	205 €	245 €	324 €	398 €	463 €	552 €
6 Kg/cm <sup>2</sup>	Ref.	386210	386211	386212	386214	386216	386218
	Price	19 330 €	22 209 €	26 180 €	30 823 €	38 467 €	45 071 €
	Δ 100 mm	229 €	279 €	345 €	403 €	530 €	635 €
Recomended!	Sightglass	+435 €	+435 €	+435 €	+435 €	+530 €	+530 €
Minimum C for manhole		1320	1300	1310	1270	1250	1250
Maximum C for 1 cylinder		2070	2050	2060	2020	2000	2000

We can manufacture filters for higher cylindrical height (please check with us)

# DPC SERIES Ø 2040-3000

## DPC SERIES

Manufactured and calculated according to EN 13121-3.  
 Material: Hand lay-up polyester with fiberglass (max quality polyester tech).  
 Steel reinforced GRP vessel.  
 Flanged connections for INLET/OUTLET or PVC lid in the bottom.  
 All connections are part of the structure of the filter in GRP.  
 Closed legs & part of the filter structure.  
 Side manhole & elliptical top manhole.  
 Design temperature 40°C.  
 Bottom nozzle plate (GRP + Steel).  
 Leg extension for bottom connection (up to 500 mm) or complete drain.  
 Tested 1.5 times design pressure

## ADDITIONAL OPTIONS

Higher temperatures. (Ask us)  
 High-chemical resistance. (Ask us) [See page 31](#)  
 Cylindrical height ad-hoc. ([Check below](#))  
 Additional sight glass. [See page 31](#)  
 Additional flanges. [See page 31](#)  
 Anchorage system to ground. [See page 31](#)  
 Seismic calculations. (Ask us)  
 Drinking water / Food contact. (Ask us)  
 Lateral manhole Ø500 mm.

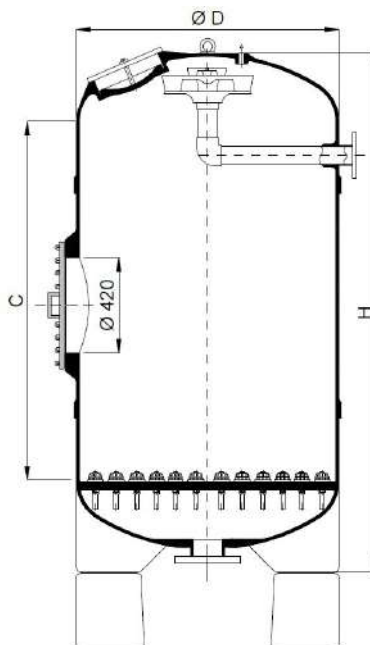

Flanged connections    Plastized Manhole lid    GRP Elliptical manhole lid    Steel ARMORED Nozzle plate    Optional sightglass    Diffuser for Ionic Exchange    Leg extension in GRP    Standard bottom flange    Customizable height

Design Pressure		DPC-2040 C=1500 *H=2515	DPC-2210 C=1735 *H=2840	DPC-2340 C=1730 *H=2850	DPC-2550 C=1730 *H=2920	DPC-2800 C=1710 *H=3040	DPC-3000 C=1760 *H=3070
2.5 Kg/cm <sup>2</sup>	Ref.	382120	382122	382123	382125	382128	382130
	Price	35 155 €	39 446 €	42 358 €	49 349 €	56 304 €	64 980 €
	Δ 100 mm	444 €	456 €	485 €	572 €	734 €	991 €
4 Kg/cm <sup>2</sup>	Ref.	384120	384122	384123	384125	384128	384130
	Price	41 077 €	46 232 €	48 862 €	58 142 €	70 027 €	76 770 €
	Δ 100 mm	497 €	520 €	566 €	647 €	788 €	1 043 €
5 Kg/cm <sup>2</sup>	Ref.	385120	385122	385123	385125	385128	385130
	Price	43 820 €	51 483 €	54 775 €	64 488 €	75 371 €	87 752 €
	Δ 100 mm	582 €	627 €	670 €	757 €	905 €	1 065 €
6 Kg/cm <sup>2</sup>	Ref.	386120	386122	386123	386125	386128	386130
	Price	46 941 €	56 905 €	60 209 €	69 613 €	83 519 €	96 169 €
	Δ 100 mm	716 €	751 €	797 €	866 €	943 €	1 091 €
Recommended!	Sightglass	+625 €	+625 €	+625 €	+625 €	+625 €	+625 €
Minimum C for manhole		1500	1735	1730	1730	1710	1760
Maximum C for 1 cylinder		2535	2485	2480	2560	2540	2460

We can manufacture filters for higher cylindrical height (please check with us)

# DPPC SERIES Ø 2040-3000

## DPPC SERIES

Manufactured and calculated according to EN 13121-3.  
 Material: Hand lay-up polyester with fiberglass (max quality polyester tech).  
 Steel reinforced GRP vessel.  
 Flanged connections for INLET/OUTLET or PVC lids.  
 All connections are part of the structure of the filter in GRP.  
 Closed legs & part of the filter structure.  
 Side manhole.  
 Design temperature 40°C.  
 Bottom nozzle plate. (GRP + Steel)  
 Top nozzle plate. (GRP + Steel)  
 Leg extension for bottom connection (up to 500 mm) or complete drain.  
 Tested 1.5 times design pressure  
 Resin transfer bluing DN80 included

## ADDITIONAL OPTIONS

Higher temperatures. (Ask us)  
 High-chemical resistance. (Ask us) [See page 31](#)  
 Cylindrical height ad-hoc. ([Check below](#))  
 Additional sight glass. [See page 31](#)  
 Additional flanges. [See page 31](#)  
 Anchorage system to ground. [See page 31](#)  
 Seismic calculations. (Ask us)  
 Drinking water / Food contact. (Ask us)  
 Lateral manhole Ø500 mm.

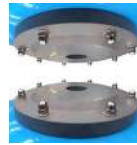
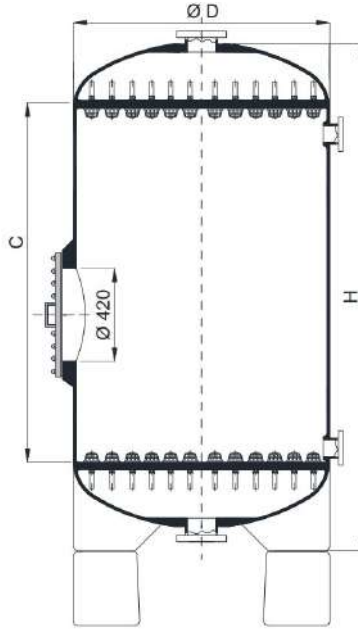

Optional Flanged Load/Unload

Plastized Manhole lid

2 x Steel ARMORED Nozzle plate

Optional sightglass

Leg extension in GRP

Optional Lid connections

Standard flanged connections

Customizable height

Design Pressure		DPPC-2040 C=1650 *H=2720	DPPC-2210 C=1655 *H=2840	DPPC-2340 C=1660 *H=2850	DPPC-2550 C=1680 *H=2920	DPPC-2800 C=1680 *H=3040	DPPC-3000 C=1710 *H=3070
2.5 Kg/cm <sup>2</sup>	Ref.	382220	382222	382223	382225	382228	382230
	Price	47 369 €	52 533 €	56 183 €	65 515 €	76 388 €	87 338 €
	Δ 100 mm	444 €	456 €	485 €	572 €	734 €	991 €
4 Kg/cm <sup>2</sup>	Ref.	384220	384222	384223	384225	384228	384230
	Price	53 313 €	59 304 €	62 639 €	74 230 €	90 096 €	99 104 €
	Δ 100 mm	497 €	520 €	566 €	647 €	788 €	1 043 €
5 Kg/cm <sup>2</sup>	Ref.	385220	385222	385223	385225	385228	385230
	Price	56 243 €	64 460 €	68 487 €	80 522 €	95 404 €	110 089 €
	Δ 100 mm	582 €	627 €	670 €	757 €	905 €	1 065 €
6 Kg/cm <sup>2</sup>	Ref.	386220	386222	386223	386225	386228	386230
	Price	59 691 €	69 839 €	73 884 €	85 638 €	103 539 €	118 479 €
	Δ 100 mm	716 €	751 €	797 €	866 €	943 €	1 091 €
Recommended!	Sightglass	+625 €	+625 €	+625 €	+625 €	+625 €	+625 €
Minimum C for manhole		1650	1655	1660	1680	1680	1710
Maximum C for 1 cylinder		2480	2405	2410	2510	2510	2410

We can manufacture filters for higher cylindrical height (please check with us)

# DPPP/KPPP SERIES Ø 415-3000 (THREE NOZZLE PLATE)

## DPPP/KPPP SERIES

Manufactured and calculated according to EN 13121-3.  
 Material: Hand lay-up polyester with fiberglass (max quality polyester tech).  
 Steel reinforced GRP vessel.  
 Flanged connections for INLET/OUTLET or PVC lid in the bottom.  
 All connections are part of the structure of the filter in GRP.  
 Closed legs & part of the filter structure.  
 2 x Side manhole.  
 Design temperature 40°C.  
 Top mid & bottom nozzle plate. (GRP + Steel)  
 Longer legs for bottom connection or complete drain.  
 Tested 1.5 times design pressure

## ADDITIONAL OPTIONS

Higher temperatures. (Ask us)  
 High-chemical resistance. (Ask us) [See page 31](#)  
 Cylindrical height ad-hoc.  
 Additional sight glass. [See page 31](#)  
 Additional flanges. [See page 31](#)  
 Anchorage system to ground. [See page 31](#)  
 Seismic calculations. (Ask us)  
 Drinking water / Food contact. (Ask us)  
 Lateral manhole Ø500 mm. [See page 31](#)

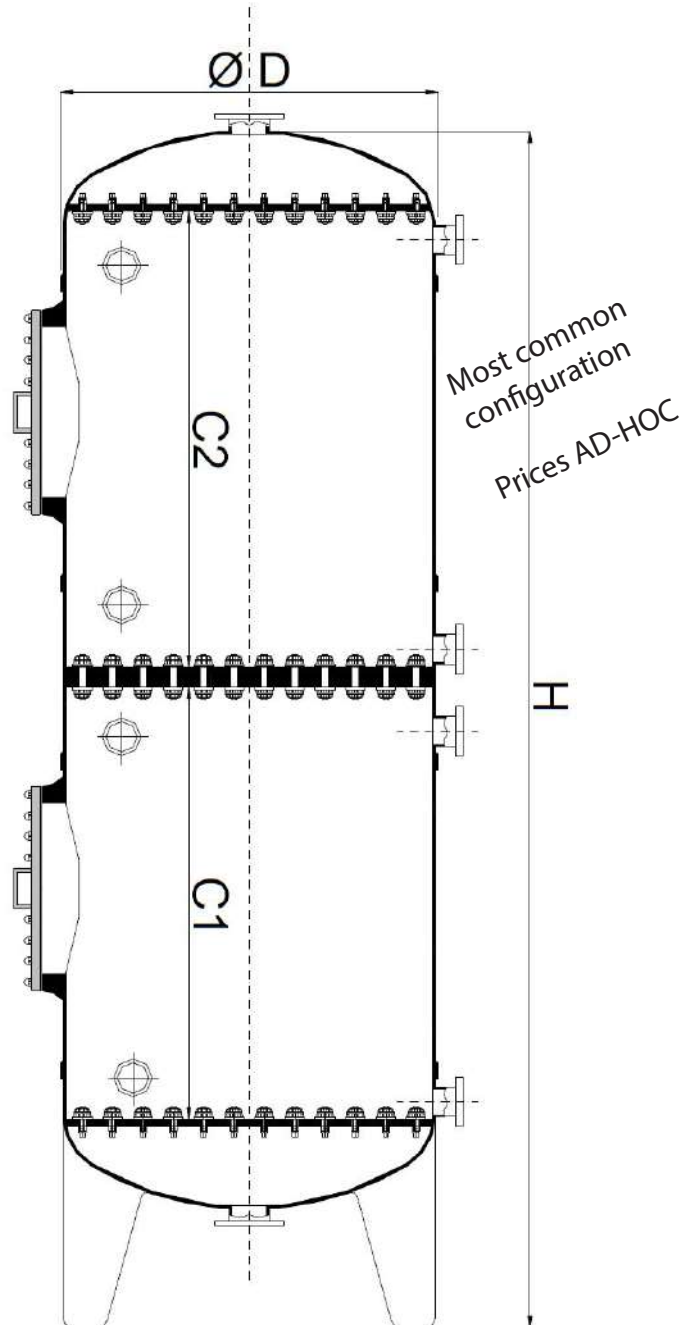

4 x Flanged Load/Unload



2 x Plastiziced Manhole lid



3 x Steel ARMORED Nozzle plate



Mid plate double thickness



4 x Sightglass



Optional Lid connections



Long legs detail

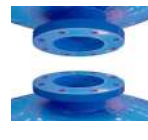

Optional flanged connections



Customizable height

# MB SERIES Ø 415-3000 (MIXED BEDS)

## MIXED BEDS

Manufactured and calculated according to EN 13121-3.  
 Material: Hand lay-up polyester with fiberglass (max quality polyester tech).  
 Steel reinforced GRP vessel.  
 Flanged connections for INLET/OUTLET or PVC lid in the bottom.  
 All connections are part of the structure of the filter in GRP.  
 Closed legs & part of the filter structure.  
 Side manhole & elliptical top manhole.  
 Design temperature 40°C.  
 Bottom nozzle plate. (GRP + Steel)  
 Longer legs for bottom connection or complete drain.  
 Mid distributor included.  
 Tested 1.5 times design pressure

## ADDITIONAL OPTIONS

Higher temperatures. (Ask us)  
 High-chemical resistance. (Ask us) [See page 31](#)  
 Cylindrical height ad-hoc.  
 Additional sight glass. [See page 31](#)  
 Additional flanges. [See page 31](#)  
 Anchorage system to ground. [See page 31](#)  
 Seismic calculations. (Ask us)  
 Drinking water / Food contact (Ask us)  
 Lateral manhole Ø500 mm. [See page 31](#)  
 Mid distributor provided by engineering company (Ask us).

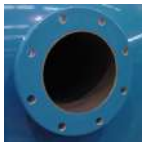
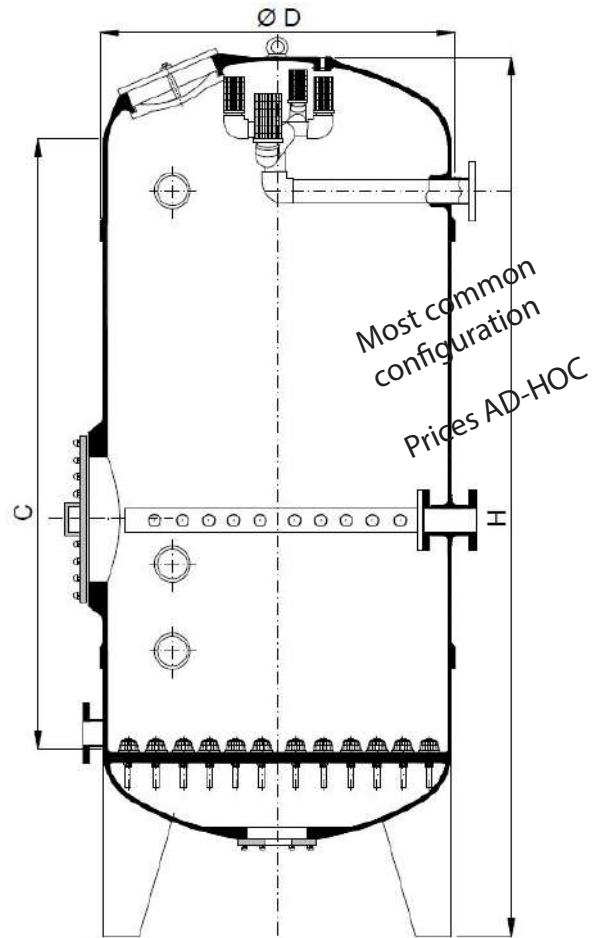

Flanged connections



Plastized Manhole lid



GRP Elliptical manhole lid



Steel ARMORED Nozzle plate



3 x Sightglass



Diffuser for Ionic exchange

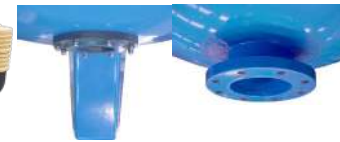

Standard bottom connection



Optional bottom flange



Customizable height

## Types of mid distributors



Stainless Steel star with PP nozzles



Stainless Steel beams with PP arms



Stainless Steel beams with Steel arms (provided by customer)



Stainless Steel beams with Steel nozzles (provided by customer)



GRP beams with PP Arms



GRP beams with PP nozzles

# STANDARD PUMP STRAINERS

Ref	ID	Connections	Basket	Max press.	Price
410811.S	P8/110	DN100	8 litres	1 bar	2 300 €
411511.S	P15/110	DN100	15 litres	1 bar	2 750 €
412516.S	P25/160	DN150	25 litres	1 bar	2 990 €
412522.S	P25/225	DN200	25 litres	1 bar	3 090 €
416030.S	P60/300	DN300	60 litres	1 bar	4 250 €

## CHARACTERISTICS

1 bar Max. pressure.  
 Quick opening device.  
 316 Stainless steel Ø4 mm hole.  
 Extremely robust.  
 Designed for suction side.

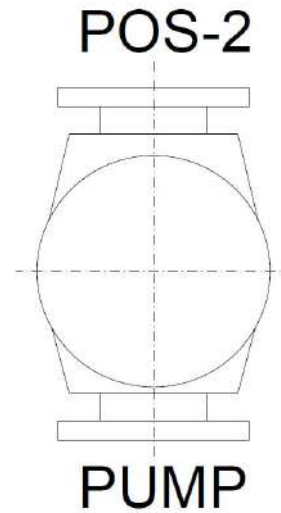
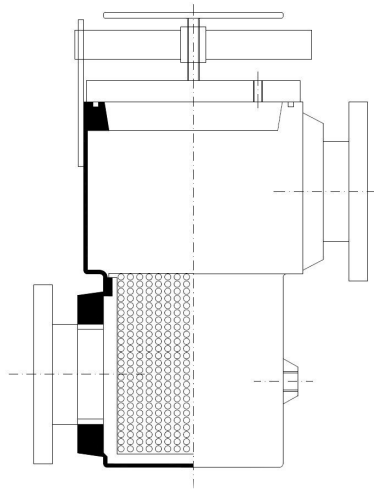

## STANDARD PUMP STRAINERS COLLECTORS

Ref	ID	Aspiration	Pump	Basket	Max press.	Price
412516.22	P25/2x160-225	2xDN150	DN200	25 litres	1 bar	3 405 €
412522.16	P25/225-2x160	DN200	2xDN150	25 litres	1 bar	3 405 €
416022.30	P60/2x225-300	2 x DN200	DN300	60 litres	1 bar	4 590 €
416030.22	P60/300-2x225	DN300	2xDN200	60 litres	1 bar	4 590 €

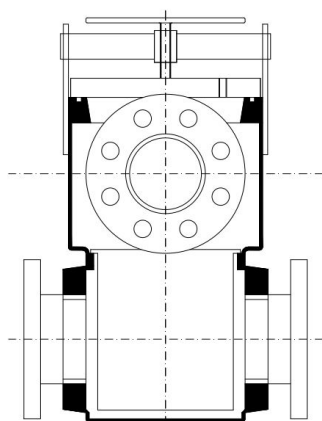

1 INLET - 2 OUTLET



Example: 1 aspiration / 2 pump

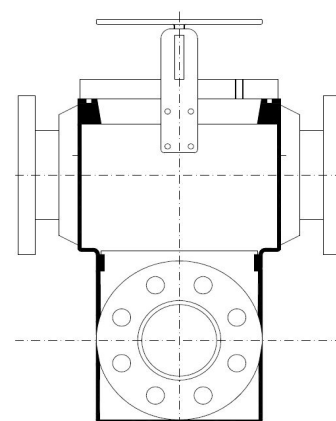

2 INLET - 1 OUTLET

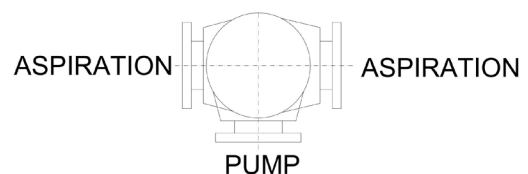
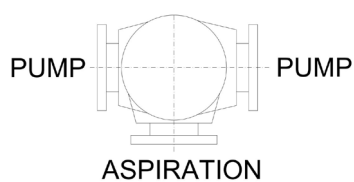



# CUSTOMIZED PUMP STRAINERS

Basket capacity: 4 l   ~ Flow 30 m³/h				Basket capacity: 8 l   ~ Flow 80 m³/h				Basket capacity: 15 l   ~ Flow 120 m³/h			
Ref	ID	Connections	Price	Ref	ID	Connections	Price	Ref	ID	Connections	Price
4104.C	P4/C	DN25 to DN80	1 920 €	4108.C	P8/C	DN40 to DN150	2 890 €	4115.C	P15/C	DN65 to DN200	3 350 €

Basket capacity: 25 l   ~ Flow 250 m³/h				Basket capacity: 60 l   ~ Flow 350 m³/h				Basket capacity: 75 l   ~ Flow 600 m³/h			
Ref	ID	Connections	Price	Ref	ID	Connections	Price	Ref	ID	Connections	Price
4125.C1	P25/C1	DN80 to DN150	3 600 €	4160.C1	P60/C1	DN110 to DN200	4 950 €	4175.C1	P75/C1	DN250 to DN350	5 600 €
4125.C2	P25/C2	DN175 to DN250	3 800 €	4160.C2	P60/C2	DN200 to DN350	5 090 €	4175.C2	P75/C2	DN400 to DN500	6 250 €

## PUMP STRAINERS

Flanged connections for INLET/OUTLET  
 All connections are part of the structure of the filter in GRP.  
 1 bar Max. pressure.  
 Quick opening device.  
 316 Stainless steel Ø4 mm hole.  
 Extremely robust.  
 Designed for suction side.  
 Basket hole Ø4 mm.  
 Flange position customizable in angle.  
 Design temperature 40°C.

## ADDITIONAL OPTIONS

Different Inlet/Outlet flange sizes in same strainer.  
 Stainless steel 316 available at order. [See yellow boxes](#)  
 Optional basket hole size Ø2mm.

### USE IT AS A COLLECTOR!

Multiple flanges for inlet or outlet .  
 Just add price of flange. [See page 20](#)

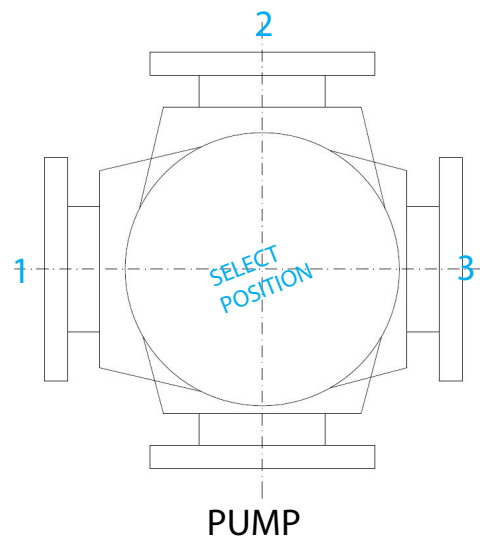
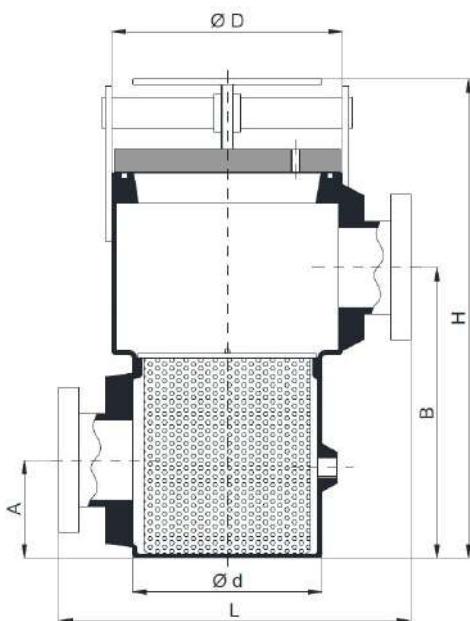

PUMP



Basket 316 SS    Integrated GRP Flanges    Transparent lid Fast opening    Emptying thread

MODEL	D	d	H	L	A	B
P4	250	200	500	370	100	290
P8	305	250	635	450	130	370
P15	355	300	760	500	150	455
P25	415	355	785	580	165	495
P60	530	480	1030	700	260	695
P75	530	480	1260	700	300	850

# DEGASSIFIERS Ø 415 - 2550

## DEGASSIFIERS

Atmospheric vessel.  
 Material: Hand lay-up polyester with fiberglass (max quality polyester tech).  
 Steel reinforced GRP vessel.  
 Flanged connections for INLET/OUTLET or PVC lid in the bottom.  
 All connections are part of the structure of the filter in GRP.  
 Closed legs & part of the filter structure.  
 Side manhole.  
 Design temperature 40°C.  
 Drilled plate or PVC grid (According to diameter)

## ADDITIONAL OPTIONS

Higher temperatures. (Ask us)  
 High-chemical resistance. (Ask us) [See page 31](#)  
 Cylindrical height ad-hoc. (Check below)  
 Additional sight glass. [See page 31](#)  
 Additional flanges. [See page 31](#)  
 Anchorage system to ground. [See page 31](#)  
 Seismic calculations. (Ask us)  
 Additional tank available. [See page 28](#) ----->



G-415 - G-960

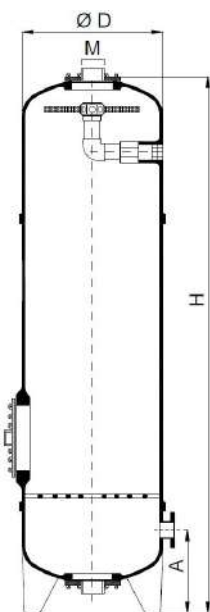

G-1010 - G-2550

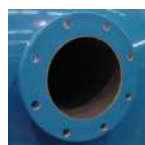
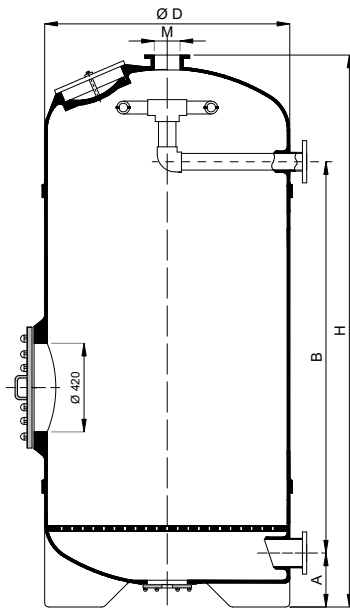

Flanged connections



Plastized Manhole lid



GRP Elliptical manhole lid



Support for rings G415-G960



Support for rings G1010-G2550



Threaded connections



Optional sightglass



Customizable height

ID	G-415	G-460	G-520	G-640	G-720	G-840	G-960
Ref.	522041	522046	522052	522064	522072	522084	522096
Ø	415	460	520	640	720	840	960
H	2355	2370	2385	2435	2460	2580	2700
Price	4 592 €	5 223 €	5 622 €	6 346 €	7 040 €	7 836 €	9 252 €

ID	G-1010	G-1160	G-1260	G-1440	G-1640	G-1840	G-2040	G-2210	G-2340	G-2550
Ref.	522010	522011	522012	522014	522016	522018	522020	522022	522023	522025
Ø	1010	1160	1260	1440	1640	1840	2040	2210	2340	2550
H	2800	2900	2950	3070	3270	3270	3470	3500	3570	3740
Price	11 168 €	13 281 €	15 332 €	19 475 €	23 649 €	28 797 €	38 029 €	42 036 €	45 103 €	52 737 €

# DECANTERS Ø 1260 - 2550

## DECANTERS

Material: Hand lay-up polyester with fiberglass (max quality polyester tech).  
 Flanged connections for INLET/OUTLET.  
 All connections are part of the structure of the filter in GRP.  
 Closed legs & part of the filter structure.  
 Design temperature 40°C.

## ADDITIONAL OPTIONS

Higher temperatures. (Ask us)  
 High-chemical resistance. (Ask us)  
 Cylindrical height ad-hoc.  
 Additional sight glass. [See page 31](#)  
 Additional flanges. [See page 31](#)  
 Anchorage system to ground. [See page 31](#)  
 Seismic calculations. (Ask us)  
 Folding lids can be also included.

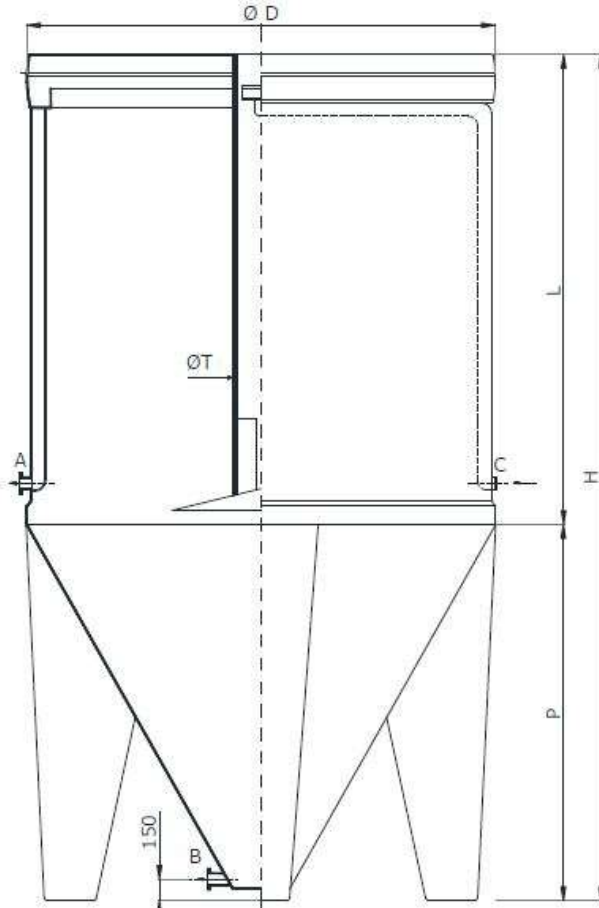

	DEC-1260	DEC-1640	DEC-2040	DEC-2340	DEC-2550
Ref.	522412	522416	522420	522423	522425
Ø	1260	1640	2040	2340	2550
P	1100	1280	1650	1900	2200
L	1200	1650	1650	1650	1650
H	2300	2930	3300	3550	3850
Price	9 190 €	11 325 €	16 206 €	18 354 €	20 971 €
Δ 800 mm	1 277 €	1 451 €	2 242 €	3 407 €	5 911 €

# TANKS & MIXING TANKS Ø 520 - 2550

## ATMOSPHERIC TANKS

Atmospheric vessel.  
 Material: Hand lay-up polyester with fiberglass (max quality polyester tech).  
 Steel reinforced GRP vessel.  
 All connections are part of the structure of the filter in GRP.  
 Design temperature 40°C.  
 R model Flat bottom  
 RP Closed legs.

## ADDITIONAL OPTIONS

Higher temperatures. (Ask us)  
 High-chemical resistance. (Ask us) [See below](#)  
 Additional sight glass. [See page 31](#)  
 Additional flanges. [See page 31](#)  
 Anchorage system to ground. [See page 31](#)  
 Seismic calculations. (Ask us)

R TANKS

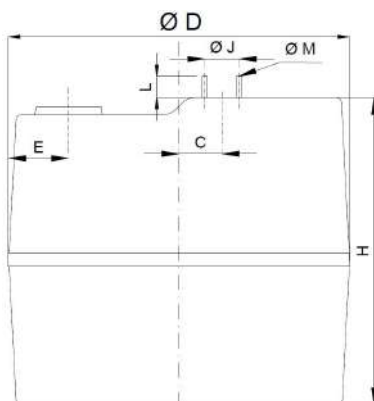

RP TANKS

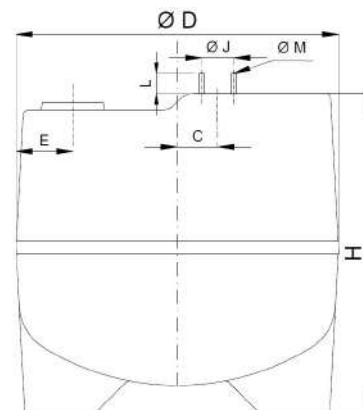

Optional Flanged connections



Optional Threaded connections



Elliptical Top Manhole

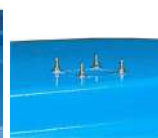

Optional Stirrer Support



Optional Water Level

Ø	520	640	720	840	1010	1260	1440	1640	2040	2040	2040	2340	2550
ID	R - 02	R - 03	R - 04	R - 06	R - 10	R - 13	R - 17	R - 25	R - 35	R - 45	R - 50	R - 75	R - 100
Ref.	522152	522164	522172	522184	522110	522112	522114	522116	522120	522121	522122	522123	522125
H	1050	1050	1050	1330	1330	1330	1330	1330	1330	1605	1880	1880	2110
Volume	200	300	400	660	975	1500	2000	2575	4000	4880	5750	7600	10000
Price	1 013 €	1 607 €	2 130 €	2 926 €	3 508 €	4 235 €	5 210 €	6 013 €	7 591 €	8 166 €	8 907 €	10 261 €	13 227 €
ID	RP - 02	RP - 03	RP - 04	RP - 06	RP - 10	RP - 13	RP - 17	RP - 25	RP - 35		RP - 50	RP - 75	RP - 100
Ref.	522252	522264	522272	522284	522210	522212	522214	522216	522220		522221	522223	522225
H	1015	1035	1065	1075	1360	1460	1500	1610	1670		1970	2035	2110
Volume	140	240	340	520	840	1350	1870	2550	4000		5000	7000	9000
Price	1 150 €	1 761 €	2 349 €	3 219 €	3 928 €	4 763 €	5 794 €	6 680 €	9 011 €		9 751 €	11 209 €	14 360 €

Price

GRP Deflector (3 inside)

400 €

Mixing funnel

320 €

Stirrer support / Tank in the top

390 €

Water level indicator

325 €

High Chemical resistance for tanks (Always check with us)

50 € + 12%

## NEED MORE VOLUME? CHECK WITH US!



# MEDIATRAPS

## MEDIATRAPS

Material: Hand lay-up polyester with fiberglass (max quality polyester tech) or PVC  
 GRP Media traps manufactured and calculated according to EN 13121-3.  
 Steel reinforced GRP vessel.  
 Flanged connections for INLET/OUTLET or PVC.  
 Design temperature 40°C.  
 KSH internal nozzles 0.2 mm.

## ADDITIONAL OPTIONS

Higher temperatures. (Ask us)  
 High-chemical resistance. (Ask us) [See page 31](#)  
 Additional sight glass. [See page 31](#)  
 Additional flanges. [See page 31](#)  
 Drinking water / Food contact. (Ask us)



OPTIONAL support  
 horizontal/vertical for S500: 515 €

ID	S - 20	S - 40	S - 100	S - 200	S - 280	S - 500
Ref.	426000	426001	426003	426005	426007	426015
Max. Flow	20 m3/h	40 m3/h	100 m3/h	200 m3/h	280 m3/h	500 m3/h
Max Connections	Ø 63 (DN 50)	Ø 90 (DN 80)	Ø	Ø 225 (DN 200)	Ø 280 (DN 250)	Ø 505(DN 350)
Diameter	Ø110	Ø230	Ø360	Ø415	Ø460	Ø730
Length	465	560	750	770	770	930
Pressure	6 kg/cm2	6 kg/cm2	6 kg/cm2	6 kg/cm2	6 kg/cm2	6 kg/cm2
Material	PVC	PVC	GRP	GRP	GRP	GRP
Price	440 €	1 495 €	2 960 €	3 770 €	4 900 €	10 900 €

# FILTRATION / PILOT PLANT SKIDS

## CALPLAS / DRYDEN AQUA FILTRATION UNITS



ID	Description	Price
64564	Calplas Filter <b>AFM-640 mm</b> , 0.3m <sup>2</sup> Speck Delta ECO VS 1.10 kW 230 V 3x Besgo DN40/d50 & air compressor Filtration control panel - APF® dosing pump. Dimensions: 1500 x 780 x 1800 mm (l * w * h) <b>AFM bags: G3:2 / G2:2 / G1:10 Not included</b>	15 990 €
64572	Calplas Filter <b>AFM-720 mm</b> , 0.4m <sup>2</sup> Speck Delta ECO VS 1.10 kW 230 V 3x Besgo DN50/d63 & air compressor Filtration control panel - APF® dosing pump. Dimensions: 1500 x 780 x 1800 mm (l * w * h) <b>AFM bags: G3:3 / G2:2 / G1:13 Not included</b>	16 990 €
64572.S	<b>SEA WATER EDITION</b> Calplas Filter <b>AFM-720 mm</b> , 0.4m <sup>2</sup> Speck Badu 90 ECO VS 1.10 kW 230 V - seawater proof 3x Besgo DN50/d63 seawater & air compressor Filtration control panel - APF® dosing pump. Dimensions: 1500 x 780 x 1800 mm (l * w * h) <b>AFM bags: G3:3 / G2:2 / G1:13 Not included</b>	17 990 €
64596	Calplas Filter <b>AFM-960 mm</b> , 0.7m <sup>2</sup> Speck Badu ECO Motion 2.20 kW 230V 3x Besgo DN65/d75 & air compressor Filtration control panel - APF® dosing pump. Dimensions: 1850 x 1120 x 1800 mm (l * w * h) <b>AFM bags: G3:5 / G2:4 / G1:23 Not included</b>	21 990 €

Price of systems excluding AFM® & APF®



## FILTRATION WITH CALPLAS 640/720/960

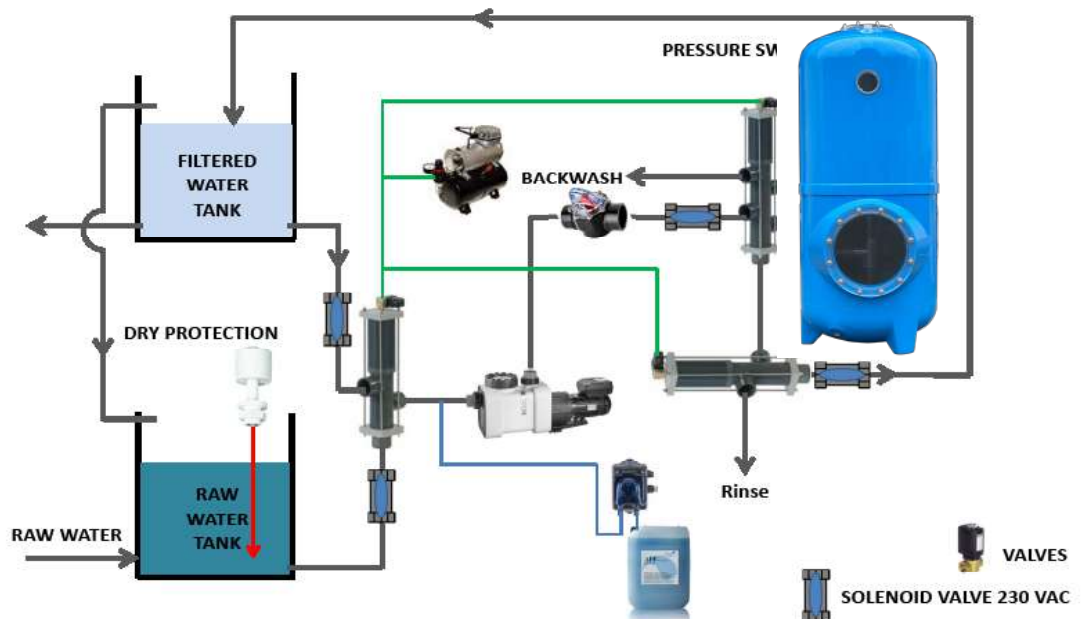

# ADDITIONAL ELEMENTS

## SIGHT GLASS



ID	Price
Circular sight glass 2 1/2" - From Ø415 to Ø520	300 €
Circular sight glass 3" - From Ø640 to Ø840	375 €
Circular sight glass 4" - From Ø960 to Ø1440	435 €
Circular sight glass 5" - From Ø1640 to Ø1840	530 €
Circular sight glass 6" - From Ø2040 to Ø3000	625 €

CHEMICAL LINING INCREASES  
SEE BELOW

Standard Lining for  
Food Contact / Drinking water

50 € + 10%

## LONG SIGHT GLASS (only available for 2.5 bar design pressure)



ID	Price
Standard vertical sight glass 200 mm	900 €
Long vertical sight glass 300 mm	1050 €

Anionic Column Regeneration  
(NaOH[5%])  
Tmax in regeneration=30°C  
Higher values check with us

50 € + 8%

Cationic Column Regeneration  
(HCl or H<sub>2</sub>SO<sub>4</sub>)[5%]  
Tmax in regeneration=30°C  
Higher values check with us

50 € + 7%

Cationic Column Regeneration  
(NaCl)

0 %

## THREADED I/O



ID	Price
Threaded I/O - from 1/2" up to 1"	80 €
Threaded I/O - from 1 1/4" to 2"	105 €
Threaded I/O - from 2 1/2" to 4"	135 €

Anionic or Cationic Column Regeneration  
+ Standard Lining  
Food Contact / Drinking water  
NaOH HCl H<sub>2</sub>SO<sub>4</sub>[5%]  
Tmax in regeneration=30°C  
Higher values check with us

50 € + 12%

## FLANGES

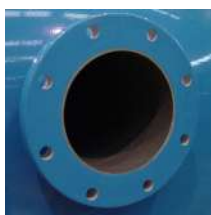

ID	Price
Polyester flange - from DN15 up to DN 25	160 €
Polyester flange - from DN32 up to DN 65	290 €
Polyester flange - from DN 80 up to DN 100	370 €
Polyester flange - from DN 125	415 €
Polyester flange - from DN 150	530 €
Polyester flange - from DN 200	650 €
Polyester flange - from DN 250	720 €
Polyester flange - from DN 300	770 €
Polyester flange - from DN 350	895 €
Polyester flange - from DN 400	1 020 €
Polyester flange - from DN 450	1 130 €
Polyester flange - from DN 500	1 255 €

ACS certification

Check with us.

Ozone max 1 ppm

50 € + 10%

Special conditions

Check with us

## HANDHOLE



Hand hole  
Ø160/Ø200 mm

725 €

## UPGRADE MANHOLE Ø420 to Ø500

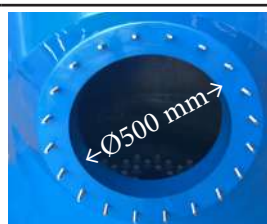

Only for Ø1010 -Ø3000  
Only Metallic lid

950 €

## PIPE SUPPORT



Per unit

255 €

## STANDARD FIXING HOLES

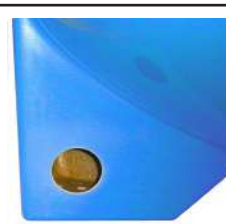

Holes for 3 legs + Access

255 €

## NAME PLATE SUPPORT



GRP plate

225 €

## WHAT IS AFM?

AFM® is quite simply the most efficient granular filtration medium available on the market. It is highly engineered to give optimum mechanical filtration performance in a range of industrial and municipal water filtration applications. Activated to increase the surface area up to 300 times that of crushed glass or sand and chemically and thermally treated to ensure permanent negatively charged surface properties that make AFM® self-sterilising.

AFM® replaces sand in all filtration applications and can be used in a conventional sand filter without modification.

## WHY AFM?

Will not support bacterial growth

At up to 20m/h will consistently filter, without flocculation:

-- >95% of 1 µ particles (Grade 1).

-- >95% of 1 µ particles (Grade 0).

Will selectively filter positively charged ionic particles such as heavy metals.

Will not suffer from channelling or preferential pathways.

Will consistently evacuate more than 95% of retained particles with 50% or less water than required for sand. (backwash duration 5 mins max at 45m/h).

Service lifespan of 10 - 15 years or more.

## CALPLAS FILTERS + AFM INSTALLATIONS



## SELF-STERILIZING SURFACE RESISTANT TO BACTERIAL GROWTH

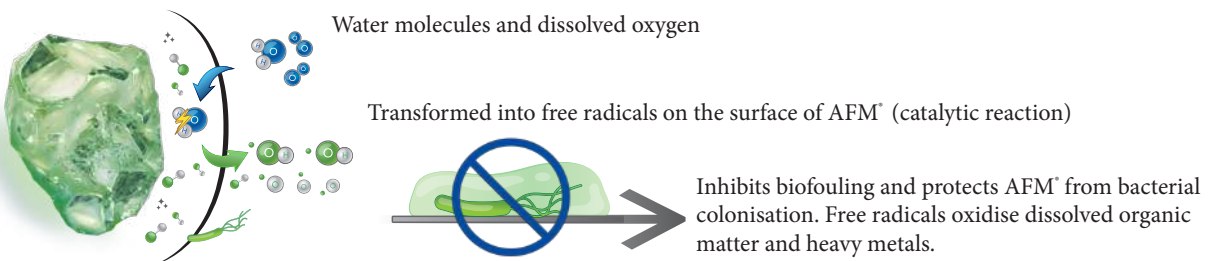

## INCREASED SURFACE AREA FOR SUPERIOR FILTRATION



Large surface area provides for superior mechanical filtration

Optimal sphericity, uniformity coefficient, particle size and shape of grain for best hydraulic performance (not round, not flat, no broken bits of glass)

Surface Area by Langmuir Isotherm Method 1'000kg: AFM = 50.000 m<sup>2</sup> / Sand 3.000 m<sup>2</sup>

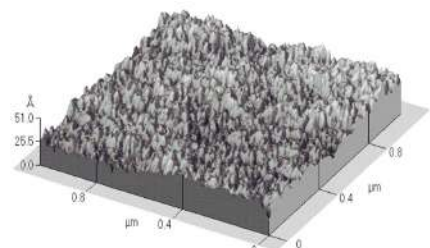



## AFM<sup>®</sup> NG HYDROPHOBIC, NEUTRAL SURFACE CHARGE



Superior mechanical filtration up to 1µm particles (95% removal)

Adsorption of organic substances including Hydrocarbon and Microplastic

## AFM<sup>®</sup>S (STANDARD) NEGATIVE SURFACE CHARGE

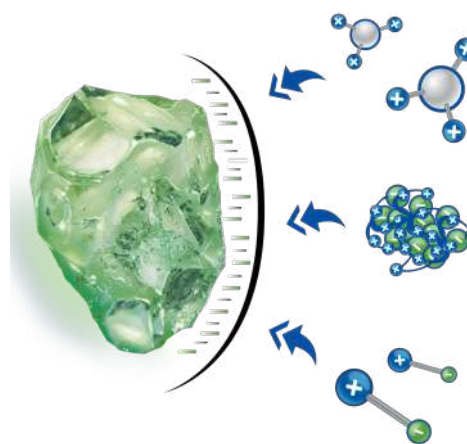

Superior mechanical filtration up to 4µm particles (98% removal)

Adsorption of positively charged particles, flocs and metals (Fe, Mn, As)

### RECOMMENDED OPERATIONAL PARAMETERS

PARAMETER	Value
Filtration velocity	1 - 30 m <sup>3</sup> /h/m <sup>2</sup>
Back Wash Velocity	30 - 50 m/h (20 m/h Ask)
Max. operating differential pressure	< 0.5 bar
Back Wash Duration	for 3 - 5/10 mins
Water pH limits	4 - 10
Water temperature limits	1 - 100°C

### AFM CERTIFICATIONS:

- ISO 9001, 14001 & 18001.
- NSF 50 & 61 for potable water use.
- DWI EC Regulation 31 certification for potable water use.
- European Water Directive (98/83/EC) & 80/778/EEC) compliant.
- BSEN12902 and BSEN12904 compliant.
- Independently tested by accredited laboratory, IFTS



Ref	ID	Package quantity	Price
6400	AFM <sup>®</sup> Grade 0 St (0.25-0.5 mm)	(25 Kg/bag)	50 €
6401	AFM <sup>®</sup> Grade 1 St (0.4-0.8 mm)	(25 Kg/bag)	50 €
6431	AFM <sup>®</sup> Grade 1 NG (0.4-0.8 mm)	(25 Kg/bag)	50 €
6432	AFM <sup>®</sup> Grade 2 NG (0.7-2.0 mm)	(25 Kg/bag)	50 €
6403	AFM <sup>®</sup> Grade 3 St (2.0-4.0 mm)	(25 Kg/bag)	50 €
6410	AFM <sup>®</sup> Grade 0 St (0.25-0.5 mm)	1 Tn/bag	2000 €
6411	AFM <sup>®</sup> Grade 1 St (0.4-0.8 mm)	1 Tn/bag	2000 €
6441	AFM <sup>®</sup> Grade 1 NG (0.4-0.8 mm)	1 Tn/bag	2000 €
6442	AFM <sup>®</sup> Grade 2 NG (0.7-2.0 mm)	1 Tn/bag	2000 €
6413	AFM <sup>®</sup> Grade 3 St (2.0-4.0 mm)	1 Tn/bag	2000 €

### ANTHRACITE & ACTIVATED CARBON



Ref	ID	Package quantity	Price
6100	Anthracite N-( 0.8 - 1.6 mm) 720 Kg/m <sup>3</sup>	(50 l/bag)	CHECK
6101	Anthracite N-( 1.4 - 2.5 mm) 720 Kg/m <sup>3</sup>	(50 l/bag)	CHECK



Ref	ID	Package quantity	Price
6200	Activated Carbon from Coconut Shells (1.18-2.36 mm) 500 Kg/m <sup>3</sup>	(50 l/bag)	285 €

# BESGO VALVES

BESGO



## 5 WAY VALVES (Standard OK for 0.5 % Salinity)

Ref	ID	Price
60040	Besgo DN40 / d50 mm / 1½" Distance 190 mm	820 €
60050	Besgo DN50 / d63 mm / 2" Distance 190 mm	895 €
60065	Besgo DN65 / d75 mm / 2½" Distance 250 mm	1 180 €
60080	Besgo DN80 / d90 mm / 3" Distance 300 mm	1 850 €
60100	Besgo DN100 / d110 mm / 4" Distance 400 mm	2 590 €
60125	Besgo DN125 / d140 mm / 5" Distance 450 mm	4 490 €
60050.S	Besgo DN50 / d63 mm / 2" Distance 190 mm <b>Sea water</b>	990 €
60065.S	Besgo DN65 / d75 mm / 2½" Distance 250 mm <b>Sea water</b>	1 425 €
60080.S	Besgo DN80 / d90 mm / 3" Distance 300 mm <b>Sea water</b>	2 290 €
60100.S	Besgo DN100 / d110 mm / 4" Distance 400 mm <b>Sea water</b>	3 190 €
60125.S	Besgo DN125 / d140 mm / 5" Distance 450 mm <b>Sea water</b>	5 490 €

## 3 WAY VALVES (Standard OK for 0.5 % Salinity)

Ref	ID	Price
60045	Besgo DN40 / d50 mm / 1½"	680 €
60055	Besgo DN50 / d63 mm / 2"	750 €
60068	Besgo DN65 / d75 mm / 2½"	990 €
60082	Besgo DN80 / d90 mm / 3"	1 590 €
60101	Besgo DN100 / d110 mm / 4"	2 300 €
60126	Besgo DN125 / d140 mm / 5"	3 990 €
60055.S	Besgo DN50 / d63 mm / 2" <b>Sea water</b>	900 €
60068.S	Besgo DN65 / d75 mm / 2½" <b>Sea water</b>	1 180 €
60082.S	Besgo DN80 / d90 mm / 3" <b>Sea water</b>	1 920 €
60101.S	Besgo DN100 / d110 mm / 4" <b>Sea water</b>	2 760 €
60126.S	Besgo DN125 / d140 mm / 5" <b>Sea water</b>	4 790 €

## HOW DOES IT WORK?

### FILTRATION

Solenoid valve closed

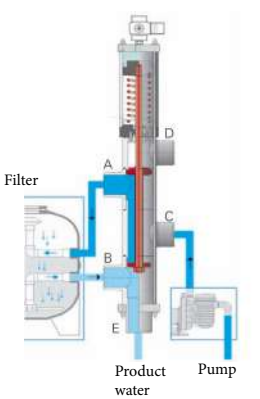

### BACKWASH

Solenoid valve open

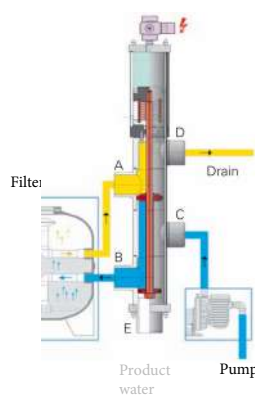

### RINSING

Solenoid of 5 way valve closed / 3-way valve open

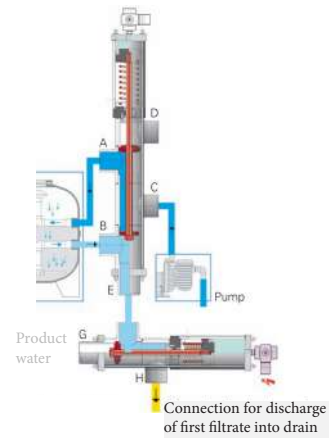

## BACKWASH VALVES

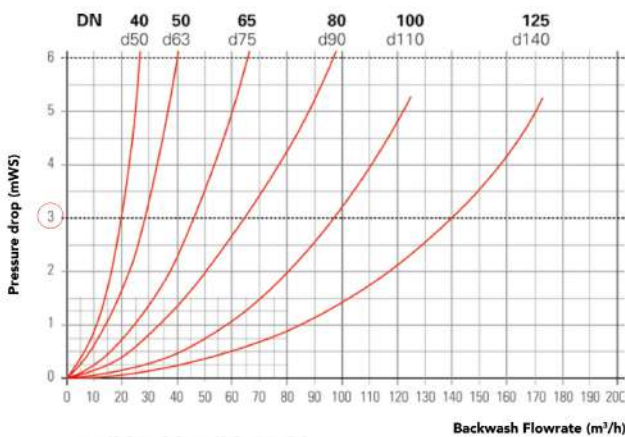

## 3-WAY VALVES

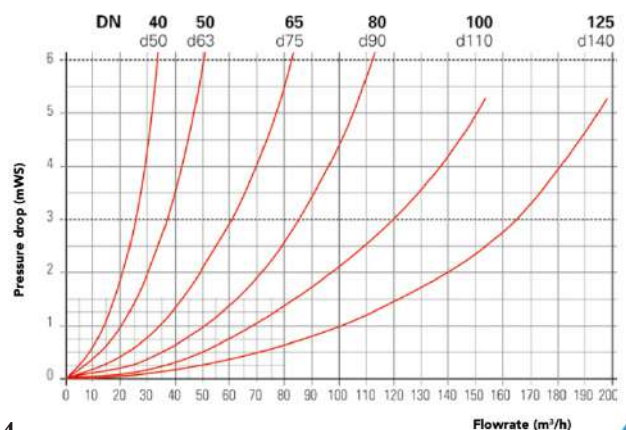

# FLOWMETERS & AIR DIFFUSERS

## FLOWMETERS



The Flow Meter FlowVis® from H2Flow can be installed in every direction and includes a non return Valve (DN 40 to DN 65). The average accuracy is 97.9%. The product is NSF 50 certified and a product of high quality. Scale in LPM.

Ref	ID	Flow	Price
63602	FlowVis® d 25/32 mm	1.2 - 5.4 m³/h	155 €
63604	FlowVis® d 50 mm	2.4-21 m³/h	230 €
63605	FlowVis® d63 mm	2.4-24 m³/h	230 €
63606	FlowVis® d75 mm	7 - 45 m³/h	270 €
63608	FlowVis® d90 mm	16-54 m³/h	690 €
63610	FlowVis® d110 mm	27-102 m³/h	730 €
63615	FlowVis® d160 mm	68 - 227 m³/h	840 €
63617	FlowVis® d200 mm	113 - 420 m³/h	930 €
63697	FlowVis® Display extension cable 8 m		255 €
63698	FlowVis® Flapper with indicator and magnet d50mm-d75mm		40 €
63699	FlowVis® Digital Display for all installations: Digital Display in casing		990 €

## AIR DIFFUSERS



Dryden Aqua Air Diffusers are the best semi flexible fine bubble aeration system available in the market. They are 5 times more efficient than coarse bubble air diffusers in mixing action and aeration capacity, with an average bubble size of 1 mm. They usually connect to a circular ring main pipe with quick connections. The ring main pipe connects to a low pressure (around 1 bar) roots type or rotary vane air blower.

- Tubular diffuser up to 3m in length
- Air flow from 1 to 10 m³/h
- Oxygen transfer up to 5kg/kwh
- Less than 0.2 Bar (3psi) pressure differential
- Outer polyester jacket
- Internal glass bead ballast (self weighted)
- Plastic & stainless steel construction
- Simple installation
- Very easy maintenance

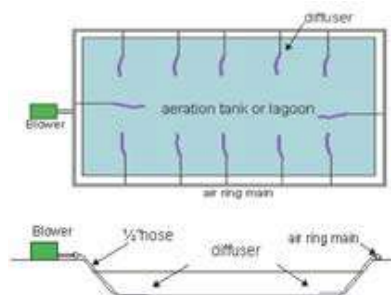

Ref	ID	Diffuser Weight kg	Air Flow m³/h (+/- 20%)	Oxygen Transfer kg of O <sub>2</sub> /day per diffuser at different depths at 20 °C and 50 % O <sub>2</sub> saturation			Price
				2 m	3 m	4 m	
64301	0.33 m Diffuser	0.5	1	2 kg O <sub>2</sub>	2.5 kg O <sub>2</sub>	3 kg O <sub>2</sub>	195 €
64303	1.00 m Diffuser	1.5	3	6 kg O <sub>2</sub>	7.5 kg O <sub>2</sub>	9 kg O <sub>2</sub>	220 €
64306	2.00 m Diffuser	3.0	6	14 kg O <sub>2</sub>	15 kg O <sub>2</sub>	18 kg O <sub>2</sub>	275 €
64309	3.00 m Diffuser	4.5	9	20 kg O <sub>2</sub>	22 kg O <sub>2</sub>	27 kg O <sub>2</sub>	320 €

In water depths of >3 - 5m there may be a tendency for the diffusers to lift. Stainless steel ballast blocks are available that fit onto the hose end of the diffusers. These have a single air connection on the top and either one or four diffuser outlets, one on each side.

64402	Dryden Aqua Weight 500 g	12 €
64403	Dryden Aqua Weight 1500 g	36 €
64405	Diffuser ring adapter	160 €



Weight for air diffuser



# USEFUL INFORMATION

## NOZZLES PER PLATE

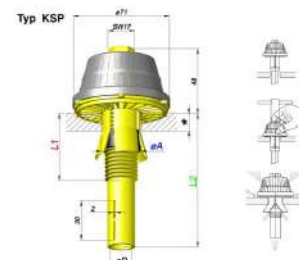
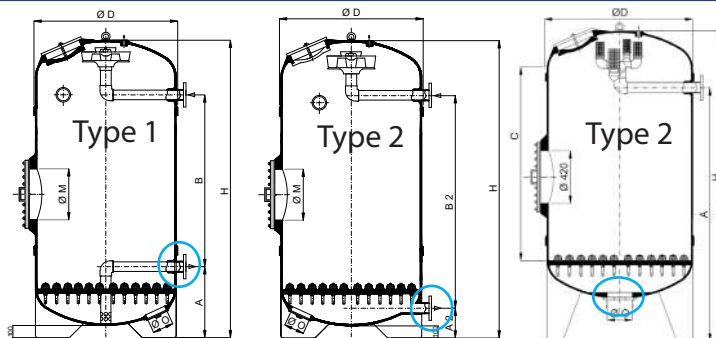

ØD	415	460	520	640	720	840	960	1010	1160	1260	1440	1640	1840	2040	2210	2340	2550	2800	3000
Type 1	12	12	15	20	24	35	43	48	64	84	96	132	172	212	235	284	336	419	484
Type 2	12	12	16	21	25	36	44	53	69	89	101	137	177	217	240	289	341	428	489

## CALPLAS INTERNAL DIAMETER/ SURFACE ACCORDING TO PRESSURE

Internal diameter estimation: This might change (Can be confirmed in manufacturing)

Diameter	2.5 kg/cm <sup>2</sup>		4 kg/cm <sup>2</sup>		5 kg/cm <sup>2</sup>		6 kg/cm <sup>2</sup>		7 kg/cm <sup>2</sup>	
	Ø Int. (mm)	Surface (m <sup>2</sup> )	Ø Int. (mm)	Surface (m <sup>2</sup> )	Ø Int. (mm)	Surface (m <sup>2</sup> )	Ø Int. (mm)	Surface (m <sup>2</sup> )	Ø Int. (mm)	Surface (m <sup>2</sup> )
415	404	0,13	*	*	402	0,13	*	*	398	0,12
460	449	0,16	*	*	445	0,16	*	*	441	0,15
520	508	0,20	*	*	504	0,20	*	*	500	0,20
640	627	0,31	*	*	622	0,30	*	*	616	0,30
720	708	0,39	*	*	702	0,39	*	*	695	0,38
840	816	0,52	*	*	810	0,52	*	*	804	0,51
960	946	0,70	*	*	938	0,69	*	*	932	0,68
1010	994	0,78	990	0,77	986	0,76	984	0,76	*	*
1160	1135	1,01	1130	1,00	1126	1,00	1122	0,99	*	*
1260	1241	1,21	1238	1,20	1234	1,20	1230	1,19	*	*
1440	1405	1,55	1396	1,53	1390	1,52	1385	1,51	*	*
1640	1610	2,04	1600	2,01	1596	2,00	1590	1,99	*	*
1840	1790	2,52	1783	2,50	1777	2,48	1770	2,46	*	*
2040	2010	3,17	2000	3,14	1988	3,10	1978	3,07	*	*
2210	2190	3,77	2177	3,72	2165	3,68	2155	3,65	*	*
2340	2275	4,06	2262	4,02	2250	3,98	2240	3,94	*	*
2550	2500	4,91	2485	4,85	2475	4,81	2465	4,77	*	*
2800	2758	5,97	2734	5,87	2728	5,84	2720	5,81	*	*
3000	2964	6,90	2937	6,77	2928	6,73	2918	6,69	*	*

## CALPLAS LEG INFORMATION / FIXING HOLES DATA

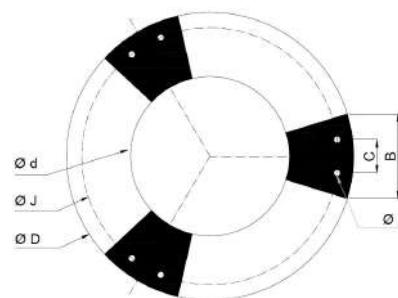

Ø	D	d	J	B	C	t
415	400	310	355	90	0	12
460	440	340	390	95	0	12
520	503	493	450	105	0	12
640	612	482	550	120	0	12
720	670	510	600	130	0	14
840	795	615	705	140	0	14
960	925	725	825	160	0	14
1010	970	470	830	250	0	16
1160	1120	620	1000	270	130	16
1260	1215	670	1125	290	150	16
1440	1380	780	1250	325	170	16
1640	1560	810	1400	370	190	16
1840	1760	1060	1610	370	200	20
2040	1980	1230	1800	410	200	20
2210	2160	1450	1960	430	220	20
2340	2240	1440	2000	450	220	20
2550	2435	1550	2200	550	250	20
2800	2700	1700	2400	570	250	20
3000	CHECK WITH US					

## FLANGES INFORMATION DIN PN10

Connection	Inch	i	D <sub>e</sub>	K	N° Holes	ØHole
DN15	1/2"	20	95	65	4	14
DN20	3/4"	25	105	75	4	14
DN25	1"	32	115	85	4	14
DN32	1 1/4"	40	140	110	4	18
DN40	1 1/2"	50	150	110	4	18
DN50	2"	63	165	125	4	18
DN65	2 1/2"	75	185	145	4	18
DN80	3"	90	200	160	8	18
DN100	4"	110	220	180	8	18
DN110	--	125	230	190	8	18
DN125	5"	*125/140	250	210	8	18
DN150	6"	160	285	240	8	22
DN175	--	200	315	270	8	22
DN200	8"	225	340	295	8	22
DN250	10"	*250/280	395	350	12	22
DN300	12	315	445	400	12	22
DN350	14	355	505	460	16	22
DN400	16	400	565	515	16	26
DN500	20	560	670	620	20	26

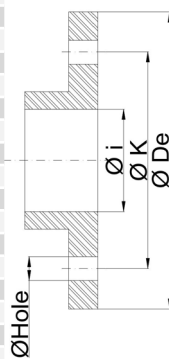

\* With this sizes, please always inform about pipe dimension.  
ANSI and JIS also available

# USEFUL INFORMATION

## CALPLAS FILTERS INFORMATION

Diameter	Standard Connection (Filters)	Besgo automatic valve compability	Manhole size (mm)	Sightglass size	Filtering surface 2.5 Kg/cm <sup>2</sup> (m <sup>2</sup> )	Volume up to the laterals (liters)	Volume for Δ 100 mm (liters)
415	2"		305	2 1/2"	0,13	10	13
460	2"		305	2 1/2"	0,16	12	16
520	2"		305	2 1/2"	0,20	16	21
640	2"		355	3"	0,31	24	31
720	2"		355	3"	0,39	37	40
840	2"		355	3"	0,52	43	53
960	2 1/2"		420	4"	0,70	61	71
1010	DN80		420 / 500	4"	0,78	97	78
1160	DN80/DN100		420 / 500	4"	1,01	176	102
1260	DN100		420 / 500	4"	1,21	195	121
1440	DN100		420 / 500	4"	1,55	206	155
1640	DN125		420 / 500	5"	2,04	277	204
1840	DN125		420 / 500	5"	2,52	444	252
2040	DN150		420 / 500	6"	3,17	417	318
2210	DN200		420 / 500	6"	3,77	707	377
2340	DN200		420 / 500	6"	4,06	836	407
2550	DN200		420 / 500	6"	4,91	903	491
2800	DN250		420 / 500	6"	5,97	1.496	598
3000	DN250		420 / 500	6"	6,90	1.431	690

## FLOW (m<sup>3</sup>/h) AT DIFFERENT VELOCITIES (Calculated 2.5 bar design pressure internal diameter)

Diameter	Flow at 5 m/h	Flow at 10 m/h	Flow at 15 m/h	Flow at 20 m/h	Flow at 25 m/h	Flow at 30 m/h	Flow at 35 m/h	Flow at 40 m/h	Flow at 45 m/h	Flow at 50 m/h	Flow at 55 m/h	Flow at 60 m/h
415	0,65	1,3	1,95	2,6	3,25	3,9	4,55	5,2	5,85	6,5	7,15	7,8
460	0,8	1,6	2,4	3,2	4	4,8	5,6	6,4	7,2	8	8,8	9,6
520	1	2	3	4	5	6	7	8	9	10	11	12
640	1,55	3,1	4,65	6,2	7,75	9,3	10,85	12,4	13,95	15,5	17,05	18,6
720	1,95	3,9	5,85	7,8	9,75	11,7	13,65	15,6	17,55	19,5	21,45	23,4
840	2,6	5,2	7,8	10,4	13	15,6	18,2	20,8	23,4	26	28,6	31,2
960	3,5	7	10,5	14	17,5	21	24,5	28	31,5	35	38,5	42
1010	3,9	7,8	11,7	15,6	19,5	23,4	27,3	31,2	35,1	39	42,9	46,8
1160	5,05	10,1	15,15	20,2	25,25	30,3	35,35	40,4	45,45	50,5	55,55	60,6
1260	6,05	12,1	18,15	24,2	30,25	36,3	42,35	48,4	54,45	60,5	66,55	72,6
1440	7,75	15,5	23,25	31	38,75	46,5	54,25	62	69,75	77,5	85,25	93
1640	10,2	20,4	30,6	40,8	51	61,2	71,4	81,6	91,8	102	112,2	122,4
1840	12,6	25,2	37,8	50,4	63	75,6	88,2	100,8	113,4	126	138,6	151,2
2040	15,85	31,7	47,55	63,4	79,25	95,1	110,95	126,8	142,65	158,5	174,35	190,2
2210	18,85	37,7	56,55	75,4	94,25	113,1	131,95	150,8	169,65	188,5	207,35	226,2
2340	20,3	40,6	60,9	81,2	101,5	121,8	142,1	162,4	182,7	203	223,3	243,6
2550	24,55	49,1	73,65	98,2	122,75	147,3	171,85	196,4	220,95	245,5	270,05	294,6
2800	29,85	59,7	89,55	119,4	149,25	179,1	208,95	238,8	268,65	298,5	328,35	358,2
3000	34,5	69	103,5	138	172,5	207	241,5	276	310,5	345	379,5	414

# AIR DIFFUSERS

## FLOWMETERS



The Flow Meter FlowVis® from H2Flow can be installed in every direction and includes a non return Valve (DN 40 to DN 65). The average accuracy is 97.9%. The product is NSF 50 certified and a product of high quality. Scale in LPM.

Ref	ID	Flow	Price
63602	FlowVis® d 25/32 mm	1.2 - 5.4 m³/h	155 €
63604	FlowVis® d 50 mm	2.4-21 m³/h	230 €
63605	FlowVis® d63 mm	2.4-24 m³/h	230 €
63606	FlowVis® d75 mm	7 - 45 m³/h	270 €
63608	FlowVis® d90 mm	16-54 m³/h	690 €
63610	FlowVis® d110 mm	27-102 m³/h	730 €
63615	FlowVis® d160 mm	68 - 227 m³/h	840 €
63617	FlowVis® d200 mm	113 - 420 m³/h	930 €
63697	FlowVis® Display extension cable 8 m		255 €
63698	FlowVis® Flapper with indicator and magnet d50mm-d75mm		40 €
63699	FlowVis® Digital Display for all installations: Digital Display in casing		990 €

## AIR DIFFUSERS



Dryden Aqua Air Diffusers are the best semi flexible fine bubble aeration system available in the market. They are 5 times more efficient than coarse bubble air diffusers in mixing action and aeration capacity, with an average bubble size of 1 mm. They usually connect to a circular ring main pipe with quick connections. The ring main pipe connects to a low pressure (around 1 bar) roots type or rotary vane air blower.

- Tubular diffuser up to 3m in length
- Air flow from 1 to 10 m³/h
- Oxygen transfer up to 5kg/kwh
- Less than 0.2 Bar (3psi) pressure differential
- Outer polyester jacket
- Internal glass bead ballast (self weighted)
- Plastic & stainless steel construction
- Simple installation
- Very easy maintenance

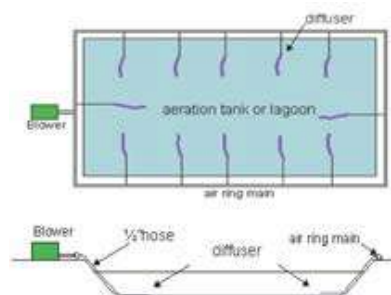

Ref	ID	Diffuser Weight kg	Air Flow m³/h (+/- 20%)	Oxygen Transfer kg of O <sub>2</sub> /day per diffuser at different depths at 20 °C and 50 % O <sub>2</sub> saturation			Price
				2 m	3 m	4 m	
64301	0.33 m Diffuser	0.5	1	2 kg O <sub>2</sub>	2.5 kg O <sub>2</sub>	3 kg O <sub>2</sub>	190 €
64303	1.00 m Diffuser	1.5	3	6 kg O <sub>2</sub>	7.5 kg O <sub>2</sub>	9 kg O <sub>2</sub>	215 €
64306	2.00 m Diffuser	3.0	6	14 kg O <sub>2</sub>	15 kg O <sub>2</sub>	18 kg O <sub>2</sub>	260 €
64309	3.00 m Diffuser	4.5	9	20 kg O <sub>2</sub>	22 kg O <sub>2</sub>	27 kg O <sub>2</sub>	300 €

In water depths of >3 - 5m there may be a tendency for the diffusers to lift. Stainless steel ballast blocks are available that fit onto the hose end of the diffusers. These have a single air connection on the top and either one or four diffuser outlets, one on each side.

64402	Dryden Aqua Weight 500 g	12 €
64403	Dryden Aqua Weight 1500 g	16 €
64405	Diffuser ring adapter	160 €



Weight for air diffuser



## PACKAGING INFORMATION IN CALPLAS EQUIPMENT

### PUMP STRAINERS & MEDIATRAPS

Calplas Pump strainers & mediatraps are sent in carton box which is included in the price.

### FA HFX AFM & VESSELS WITH THREADED CONNECTIONS

Calplas vessels with threaded connections are sent in carton box which is included in the price.

### VESSELS WITH FLANGED CONNECTIONS

Calplas vessels with flanged connections require a wooden box crate if it is sharing transport with other loads. Please see prices below.



#### FB

Model	Net Price
FB-40 to FB-80	150 €
FB-100 to FB-175	235 €
FB-200	315 €
FB-250	350 €
FB-300	380 €
FB-350	420 €

#### COLUMNS WITH FLANGES

Model	Net Price
Ø415 to Ø640 mm	100 €
Ø720 to Ø960 mm	155 €
Ø1010 to Ø1260 mm	190 €
Ø1440 to Ø1640 mm	300 €
Ø1840 to Ø2210 mm	370 €
Ø2340 mm	430 €
Ø2550 mm	530 €
Ø2800 mm	585 €
Ø3000 mm	685 €

### FULL TRUCK (DIRECT SHIPMENT TO INSTALLATION)

For some installations a direct shipment can be done, with a full truck load, under this circumstances wooden box crates can be avoided under customers responsibility not to damage the filters on the unloading process.





[calplas@calplas.com](mailto:calplas@calplas.com)  
[www.calplas.com](http://www.calplas.com)

Polígono Txirrita-Maleo  
Pabellón nº 9  
20100 Rentería (Guipuzcoa)-España  
Tel.: + 34 943 49 05 01